

DPX-1

Digital Cinema Projector
Projecteur Cinema Numerique

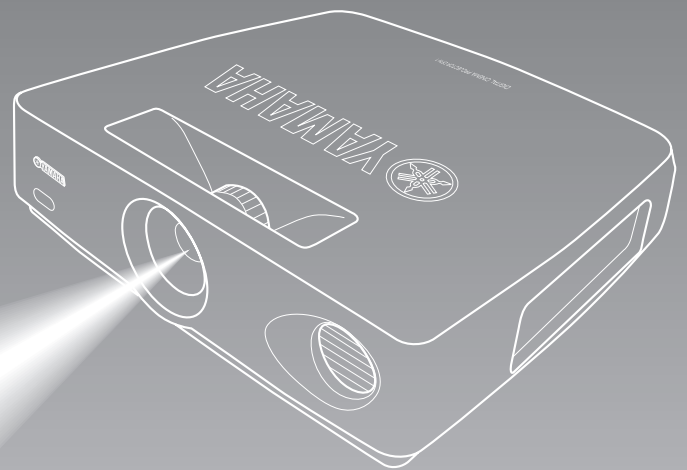

Caution: Read this before operating this unit.

- To assure the finest performance, please read this manual carefully. Keep it in a safe place for future reference.

Installation

- Install this unit in a well-ventilated, cool, dry, clean place with at least 10 cm clearance on the top, right and left, and at the back of this unit — away from direct sunlight, heat sources, vibration, dust, moisture, and/or cold.
- Locate this unit away from other electrical appliances, motors, or transformers to avoid humming sounds. To prevent fire or electrical shock, do not place this unit where it may get exposed to rain, water, and/or any type of liquid.
- Do not expose this unit to sudden temperature changes from cold to hot, and do not locate this unit in an environment with high humidity (i.e. a room with a humidifier) to prevent condensation inside this unit, which may cause an electrical shock, fire, damage to this unit, and/or personal injury.
- On the top of this unit, do not place:
 - Other components, as they may cause damage and/or discoloration on the surface of this unit.
 - Burning objects (i.e. candles), as they may cause fire, damage to this unit, and/or personal injury.
 - Containers with liquid in them, as they may cause electrical shock to the user and/or damage to this unit.
- Do not cover this unit with a newspaper, tablecloth, curtain, etc. in order not to restrict heat dissipation. If the temperature inside this unit rises too much, it may cause fire, damage to this unit, and/or personal injury.
- When installing this unit on the ceiling, make sure the ceiling has sufficient strength to support this unit and the ceiling mounts for an extended period of time. Installation must be performed only by qualified service personnel.

Operation

- Remove the lens cap before starting any operation of this unit to prevent the heat from staying around the lens. Operation with the cap on may cause damage to this unit.
- Do not plug in this unit to a wall outlet until all connections are complete.
- Only the voltage specified on this unit must be used. Using this unit with a higher voltage than specified is dangerous and may cause fire, damage to this unit, and/or personal injury. YAMAHA will not be held responsible for any damage resulting from use of this unit with a voltage other than that specified.
- Do not use force on switches, knobs and/or cords.
- Do not operate this unit upside-down. It may overheat, possibly causing damage.
- Take care of this unit so that no foreign objects and/or liquid drop inside this unit.
- To prevent damage by lightning, disconnect the power cord from the wall outlet during an electrical storm.
- Do not look into the lens while this unit is turned on. It may cause serious damage to your eyesight.
- Before moving this unit, press **STANDBY/ON** to set this unit in the standby mode, and disconnect the AC power plug from the wall outlet.
- Do not attempt to modify or fix this unit. Contact qualified YAMAHA service personnel when any service is needed. The cabinet should never be opened for any reason.

- When not planning to use this unit for a long period of time (i.e. vacation), disconnect the AC power plug from the wall outlet.
- When disconnecting the power cord from the wall outlet, grasp the plug; do not pull the cord.
- Be sure to read the “TROUBLESHOOTING” section on common operating errors before concluding that this unit is faulty.

Others

- Clean the lens carefully so as not to create any scratches by using a blower or lens paper.
- Replace the lamp when the LAMP/COVER indicator flashes in red after the lamp usage has exceeded 1000 hours. Follow the lamp replacement procedure described in this manual.

IMPORTANT

THE WIRES IN THIS MAINS LEAD ARE COLOURED IN ACCORDANCE WITH THE FOLLOWING CODE:

GREEN-AND-YELLOW:	EARTH
BLUE:	NEUTRAL
BROWN:	LIVE

As the colours of the wires in the mains lead of this apparatus may not correspond with the coloured markings identifying the terminals in your plug, proceed as follows:

The wire which is coloured GREEN-AND-YELLOW must be connected to the terminal in the plug which is marked by the letter E or by the safety earth symbol or coloured GREEN or GREEN-and-YELLOW.

The wire which is coloured BLUE must be connected to the terminal which is marked with the letter N or coloured BLACK.

The wire which is coloured BROWN must be connected to the terminal which is marked with the letter L or coloured RED.

For U.K. customers

If the socket outlets in the home are not suitable for the plug supplied with this appliance, it should be cut off and an appropriate 3 pin plug fitted. For details, refer to the instructions described below.

Note

- The plug severed from the mains lead must be destroyed, as a plug with bared flexible cord is hazardous if engaged in a live socket outlet.

For Canadian Customers

To prevent electric shock, match wide blade of plug to wide slot and fully insert.

This Class B digital apparatus complies with Canadian ICES-003.

Inappropriate places for installation

If this unit is not correctly installed in an appropriate place, it may cause fire or failure, or damage to this unit may result. Carefully choose the place to install this unit by avoiding the places listed below.

1. Places where the temperature and humidity vary greatly

- Do not install this unit in a place where the temperature and humidity become extremely high or the temperature becomes extremely low.
- This unit must be used within a temperature range of 5—35°C.

2. Places without adequate ventilation

- Install this unit with at least 10 cm (4 inch) of ventilation space on the top, right and left, and at the back of this unit.
- Do not cover the ventilation slots of this unit not to obstruct the heat dissipation.
- Install this unit on the firm surface.
- Do not cover this unit with a tablecloth, etc.
- Make sure there is nothing to get sucked into the ventilation slots so that the temperature of this unit does not become too high.

3. Places where it gets dusty

- If the air filters are blocked with dust, the temperature of this unit may become too high.

4. Places with too much vibration or impact

- Vibration and impact can damage parts of this unit.

5. Places where this unit gets exposed to water or high humidity

- If this unit is exposed to water or high humidity, it may cause a fire or electrical shock.

6. Unstable places

- If this unit is installed on an unstable or an inclined tabletop, it may fall and cause damage to this unit or personal injury.

Important

- Make sure no light other than the projecting light directly falls on the screen to ensure vivid high-contrast images.

Introduction

Thank you for purchasing this YAMAHA product. We hope it will give you many years of trouble-free enjoyment. For the best performance, read this manual carefully. It will guide you in operating your YAMAHA product.

Features

- High-brightness and high-contrast images achieved by DLP™ technology
- 0.9-inch large DMD™ chips to ensure superior image quality
- Rich gray-scale tones achieved by the tri-segment color wheel
- Quiet operation with a noise as low as 30dB by Yamaha sound effect technology
- Wide variety of input terminals to support the latest video formats
- Superior image quality achieved by high-performance 3-2 pull-down detection
- Six memory settings

(DLP™ and DMD™ are trademarks of Texas Instruments.)

Contents

INTRODUCTION

Features	1
Controls and functions	
Front panel and terminal panel	2
Control panel	3
Remote control	4
Loading the batteries in the remote control	4

INSTALLATION

How to install	
Screen and projection distance	5
Screen setting	6
Setting "SCREEN ASPECT"	6
Adjusting with "DIGITAL LENS SHIFT"	6
Installation methods	7

CONNECTIONS

How to connect	
Connecting a video component	8
Connecting a computer	9

BASIC OPERATION

Using this unit	
Turning on the power	10
Focusing	10
Selecting the input source	11
STILL—freezing the image	11
HIDE—turning off the image temporarily	11
Selecting "ASPECT"	12
Turning off this unit	14
Indicators	14

MENU

Menu structure

IMAGE	15
SIGNAL	16
INITIAL	17
SETUP	17

Menu operation

Menu screen and operating buttons	18
Basic menu operation	19
Submenu	20
Basic submenu operation	21
One-touch image menu	24
Changing the menu location	24

Memory function

Selecting the memory setting number	25
Resetting to the factory setting	26

ADDITIONAL INFORMATION

Additional information

Glossary	27
Projectable signals	28
Menu items and input signals	29
Message display	30

Maintenance

Regular care	31
Cleaning the filter	31
Replacing the lamp cartridge	32

Troubleshooting 33

Specifications

Specifications	34
Accessories	34
Dimensional drawing	35

Controls and functions

■ Front panel and terminal panel

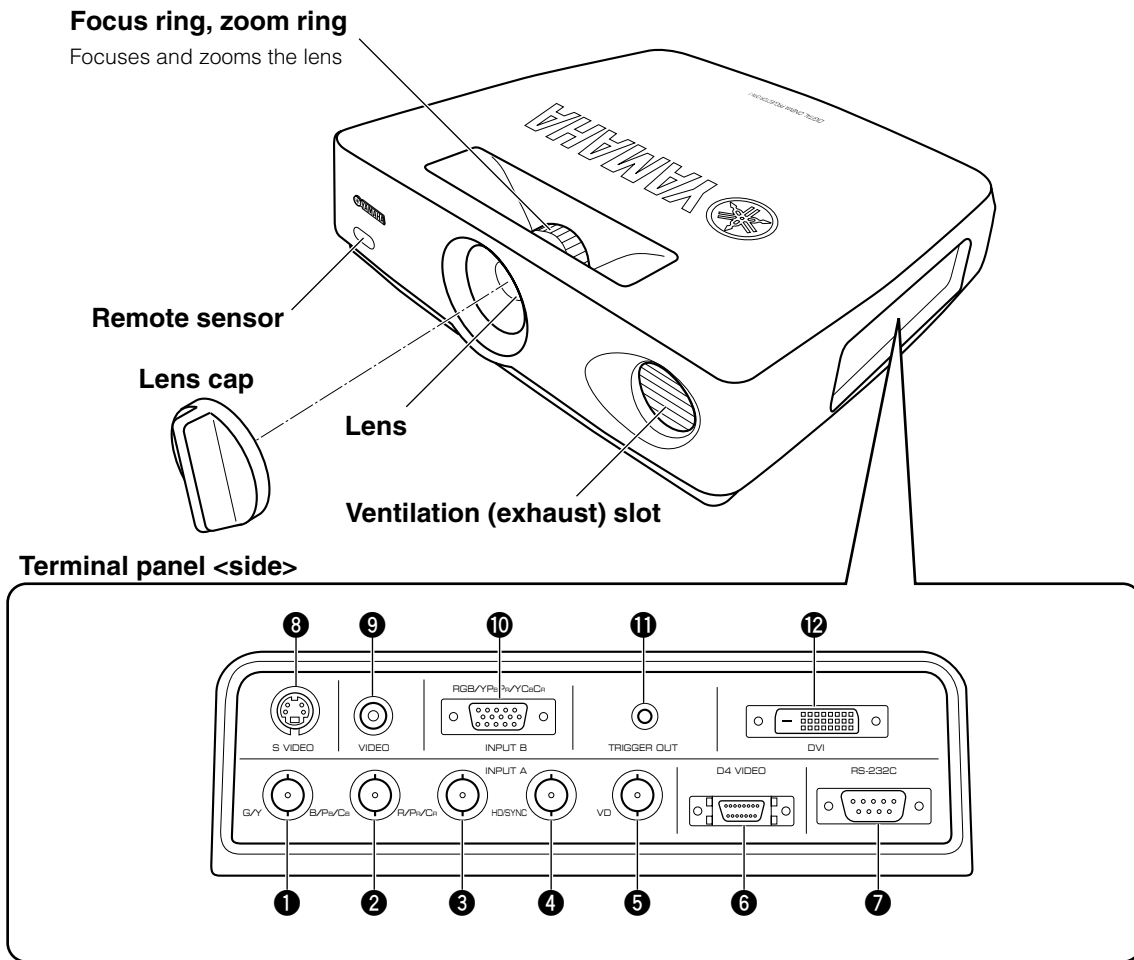

①—⑤ INPUT A (BNC jacks)

These jacks receive component video and RGB signals. Component video signals from an A/V component are sent to the ①—③ jacks. RGB signals from a computer are sent to the ①—⑤ jacks. Use a BNC cable when connecting this unit to another component.

- ① G/Y (G or luminance signal)
- ② B/P_B/C_B (B or color-difference signal)
- ③ R/P_R/C_R (R or color-difference signal)
- ④ HD/SYNC (horizontal sync signal, composite sync signal)
- ⑤ VD (vertical synchronous signal)

⑥ D4 VIDEO (D connector)

This connector receives video signals from the D connector of an A/V component and is compatible with the D1—D4 format.
* This connector is designed for the Japanese D format only.

⑦ RS-232C (D-Sub 9-pin)

This connector is used for an examination in the factory.

⑧ S VIDEO (mini DIN jack)

This jack receives S video signals from the S video jack on an A/V component. Use an S video cable when connecting this unit to another component.

⑨ VIDEO (pin jack)

This terminal is for the composite signal from the video terminal of the A/V component. Use a video pin cable.

⑩ INPUT B (D-Sub 15-pin)

This connector receives component video and RGB signals (RGB/Y_PB_PR/Y_CB_CR) from an A/V component or a computer. Use a D-Sub monitor cable when connecting this unit to another component.

⑪ TRIGGER OUT (mini jack)

This jack outputs signals to control external components. A potential of +12V will be provided while this unit is projecting.

⑫ DVI (DVI connector)

This connector receives DVI signals (digital RGB) from a computer.

■ Control panel

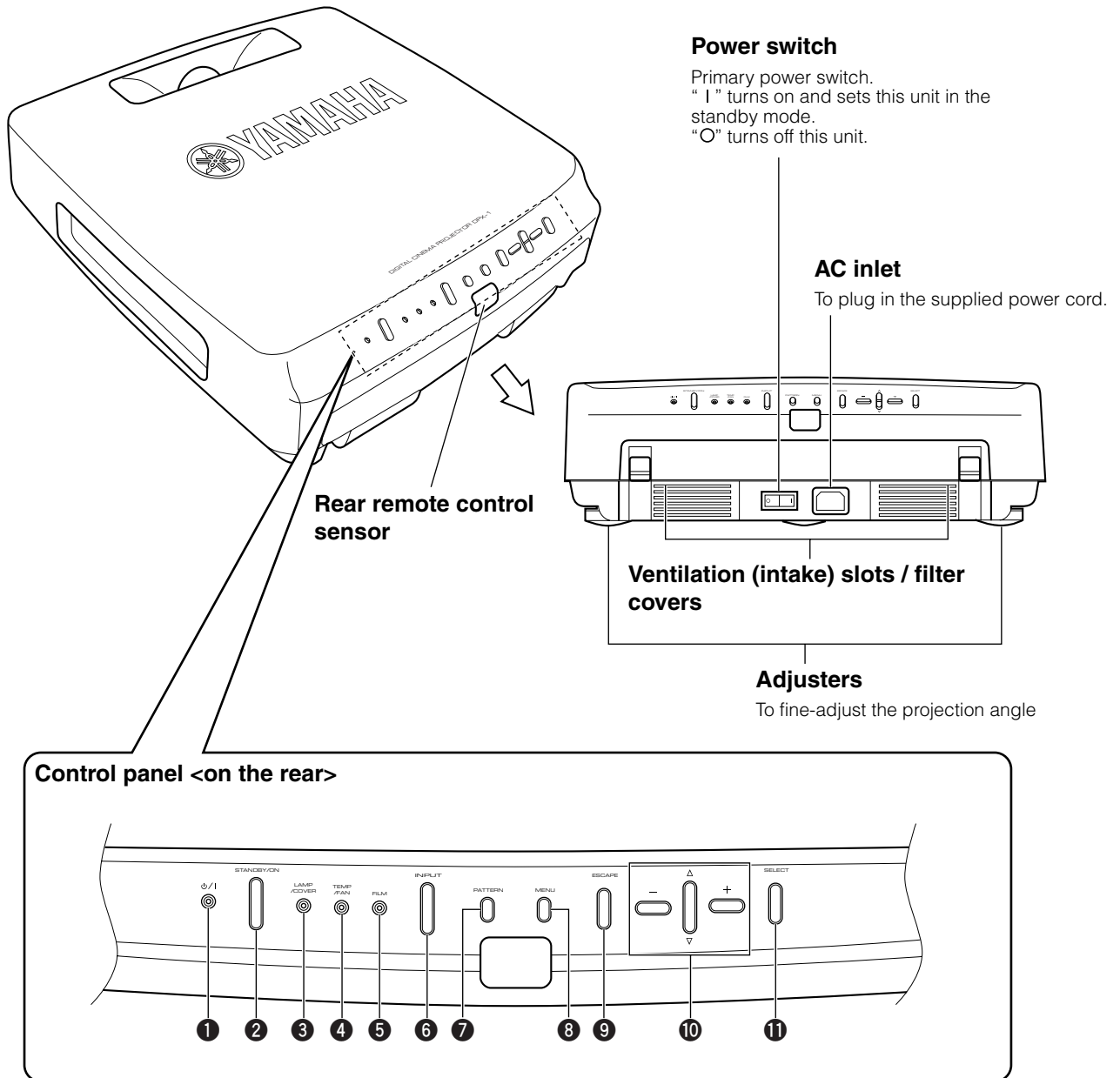

Power switch

Primary power switch.
 "I" turns on and sets this unit in the standby mode.
 "O" turns off this unit.

AC inlet

To plug in the supplied power cord.

Rear remote control sensor

Ventilation (intake) slots / filter covers

Adjusters

To fine-adjust the projection angle

Control panel <on the rear>

1 ϕ /I indicator (P.14)

2 **STANDBY/ON button (P.10)**

Secondary power button
 Turns on and sets this unit in the standby mode. This button is effective only when the primary power switch is turned on.

Standby mode
 In this mode, this unit consumes a small amount of power to receive infrared signals from the remote control.

3 **LAMP/COVER indicator (P.14)**

4 **TEMP/FAN indicator (P.14)**

5 **FILM indicator (P.14)**

6 **INPUT button (P.11)**

Turns on and off the menu to select the input terminal and the input signal.

7 **PATTERN button (P.10)**

Turns on and off the stored test patterns on the screen.

8 **MENU button (P.18)**

Turns on and off the menu to set or adjust the parameters necessary for projection.

9 **ESCAPE button (P.18)**

Closes the submenu.

10 **Cursor buttons (P.18)**

Used for the operation of Δ , ∇ , $-$, and $+$.

11 **SELECT button (P.18)**

Confirms the new setting entry, or opens the submenu.

■ Remote control

The corresponding buttons on the control panel and the remote control perform same functions. Use the remote control by aiming at the remote control sensor located on the front or back of this unit, within a distance of 7 m (23 feet). This unit may not respond when the remote control is not close enough to the vertical line to the sensor.

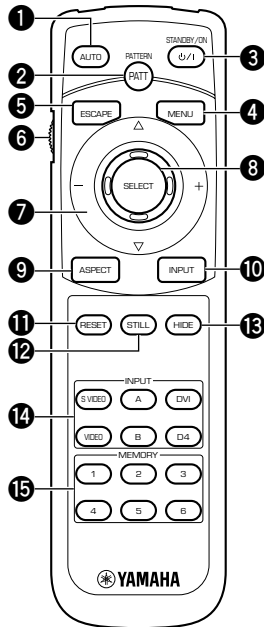

- 1 AUTO button**
Readjusts the most appropriate setting for the signal type.
- 2 PATTERN button (P.10)**
Turns on and off the stored test patterns on the screen.
- 3 STANDBY/ON button (P.10)**
Turns on and sets this unit in the standby mode. This button is effective only when the primary power switch is turned on.
- 4 MENU button (P.18)**
Turns on and off the menu display to set and adjust the parameters necessary for projection.
- 5 ESCAPE button (P.18)**
Closes the submenu.
- 6 Light switch**
Lights the operation buttons on the remote control for approximately 10 seconds when pushed upward or downward.
- 7 Cursor buttons (P.18)**
Used for the operation of Δ , ∇ , $-$, and $+$.
- 8 SELECT button (P.18)**
Confirms the new setting entry, or opens the submenu. Press the center of the button for this function.
- 9 ASPECT button (P.12)**
Selects the display aspect ratio for the images to be projected. When pressed, the current display aspect ratio is displayed. When pressed again within 2 seconds, the next display aspect ratio is displayed.

- 10 INPUT button (P.11)**
Turns on and off the menu display to select the input terminal and the input signal.
- 11 RESET button (P.18)**
Resets the parameter to its factory setting when pressed while adjusting the parameter on the menu.
- 12 STILL button (P.11)**
Stops a moving image to display a still image of the desired frame. Press again to cancel this function.
- 13 HIDE button (P.11)**
Temporarily turns off the image being projected. Press again to cancel this function.
- 14 INPUT area**
Directly selects the input terminal.
- 15 MEMORY area (P.25)**
Directly calls up the stored memory setting information.

■ Loading the batteries in the remote control

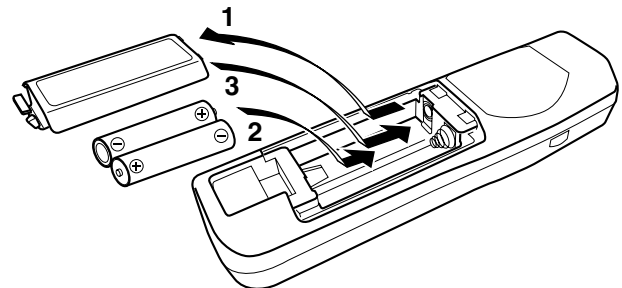

- 1. Remove the battery compartment cover from the back of the remote control.**
- 2. Insert two batteries (AA, UM-3 or R6 type) according to the polarity markings on the inside of the battery compartment.**
- 3. Close the cover until it snaps into place.**

Important

- If you find that the remote control must be used closer to this unit than usual, the batteries are weak. Replace the batteries with new ones.
- Do not mix new and old, or different types of battery.
- Remove the batteries from the remote control when planning not to use for a long period of time.
- If the batteries have leaked, wipe the inside of the battery compartment before loading new ones.

How to install

There are four ways this unit can be installed:
 installing on a tabletop in front of the screen,
 mounting on the ceiling in front of the screen,
 installing on a tabletop behind a semi-translucent screen,
 mounting on the ceiling behind a semi-translucent screen.

It is necessary to set the installation method for "INSTALLATION" in the menu group ④ <SETUP> on the menu described later. (See page 17.)

■ Screen and projection distance

The ideal position (projection distance [L]) to install this unit is determined by the screen aspect ratio (4:3 or 16:9) and the size (length of the diagonal line across the screen). It is possible to adjust the projection distance within the range from Wide to Tele. by using the zoom function. Use the following information as illustrated in the figure below to determine the best position for installation.

4:3 Screen

Screen size (inch)	Projection distance [L] (m)	Wide/Tele. (feet, inch)
60	2.4—2.9	7' 10"—9' 6"
80	3.2—3.9	10' 6"—12' 10"
100	4.0—4.9	13' 1"—16'
120	4.8—5.8	15' 9"—19'
150	6.1—7.3	20'—23' 11"
200	8.1—9.8	26' 7"—32' 2"

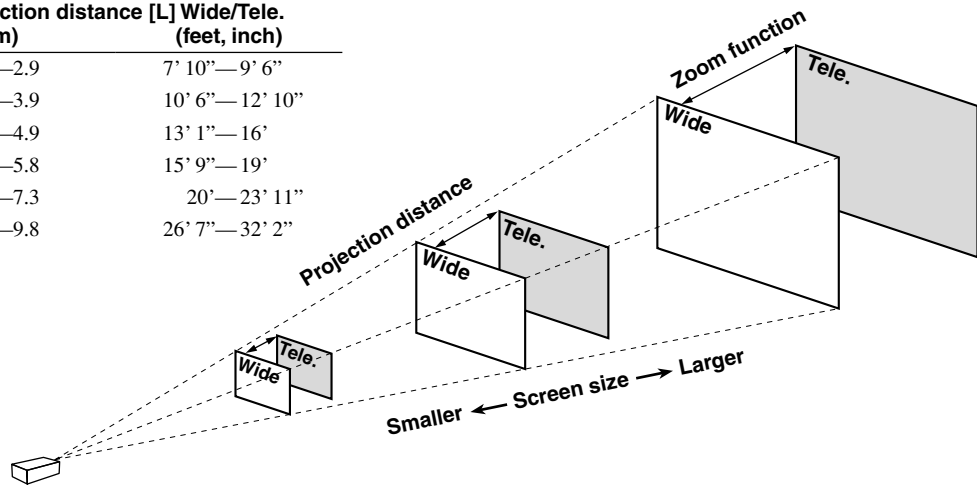

16:9 Screen

Screen size (inch)	Projection distance [L] (m)	Wide/Tele. (feet, inch)
60	2.6—3.2	8' 6"—10' 6"
80	3.5—4.2	11' 6"—13' 9"
100	4.4—5.3	14' 5"—17' 5"
120	5.3—6.4	17' 5"—21'
150	6.6—8.0	21' 8"—26' 3"
200	8.8—10.6	28' 10"—34' 9"

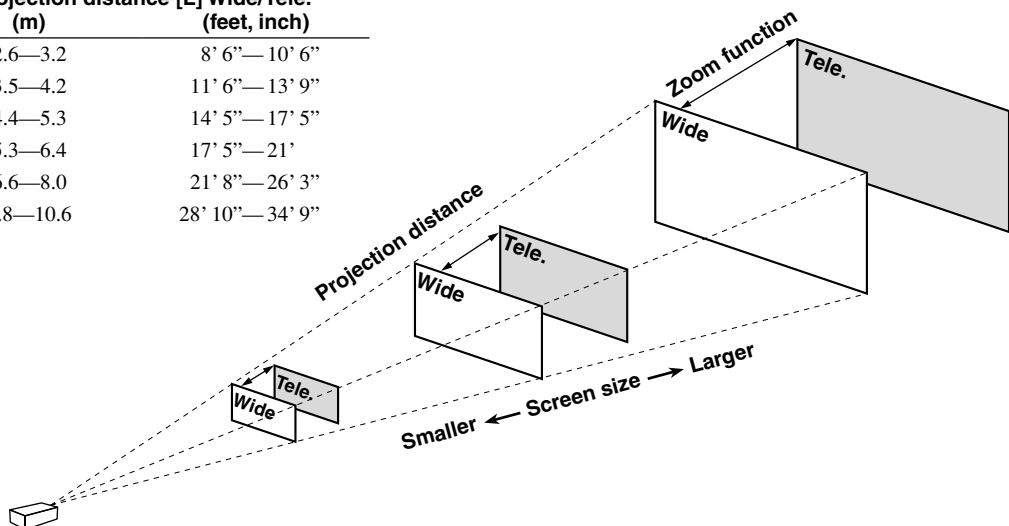

Important

- Projection distance is the horizontal distance from the lens surface of this unit to the screen. The lens is recessed for 4 cm (1-1/2 inch) from this unit's exterior.

How to install

■ Screen setting

The screen height depends on your screen size. This unit projects facing slightly upward, although projecting symmetrically about the lens center on the horizontal axis. The following charts show the height [H] from the lens center to the screen bottom. Consider dimension [H] when determining the position to set your screen.

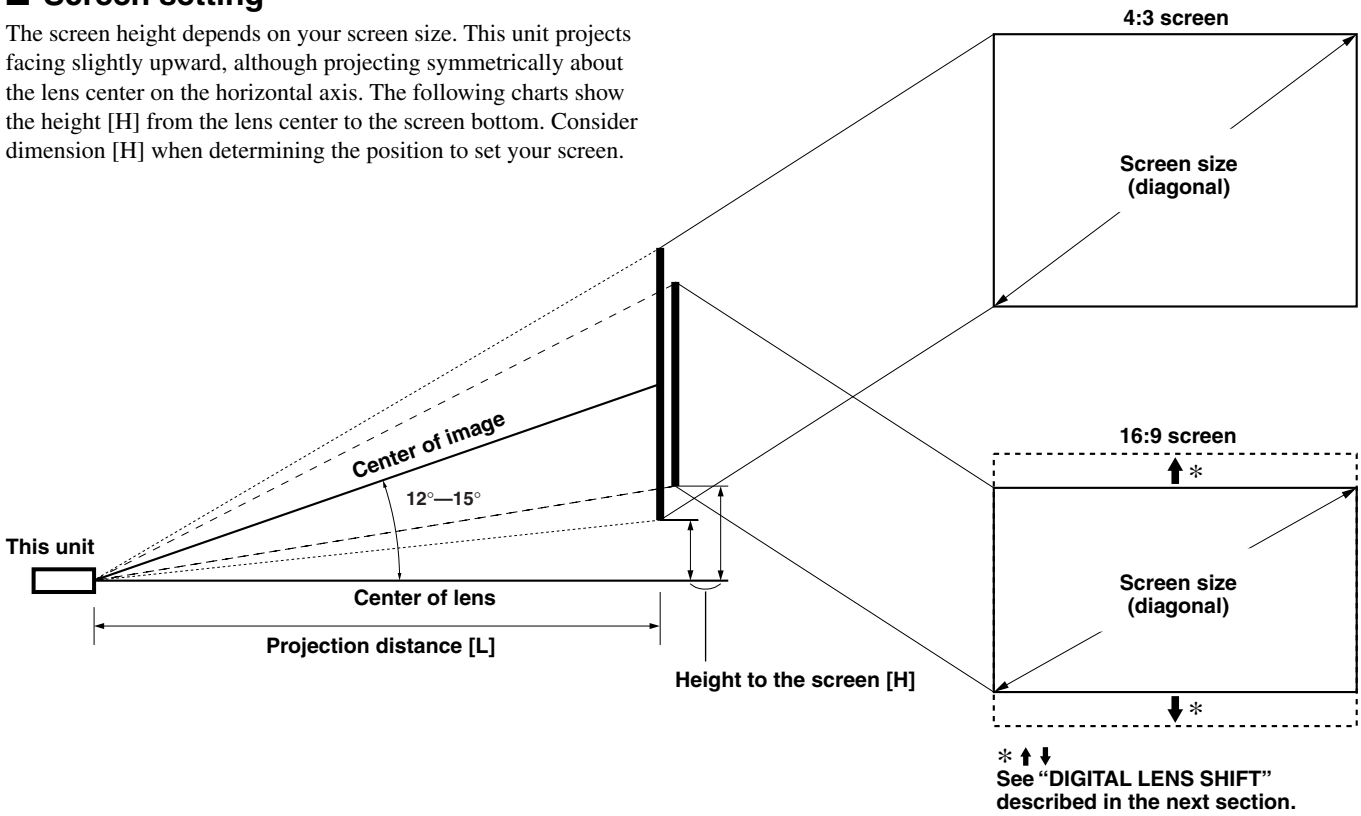

4:3 Screen

Screen size (inch)	Height to the screen bottom [H] (cm)	Height to the screen bottom [H] (inch)
60	18	7- 1/16
80	24	9- 7/16
100	30	11- 13/16
120	36	14- 3/16
150	45	17- 3/4
200	59	23- 1/4

16:9 Screen

(When "DIGITAL LENS SHIFT" is set to 0)

Screen size (inch)	Height to the screen bottom [H] (cm)	Height to the screen bottom [H] (inch)
60	32	12- 5/8
80	42	16- 1/2
100	53	20- 7/8
120	64	25- 3/16
150	80	31- 1/2
200	106	41- 3/4

■ Setting "SCREEN ASPECT"

It is necessary to set the screen aspect ratio (4:3 or 16:9) depending on your screen in order to properly project images on the entire area of the screen. When the 16:9 screen is used and "SCREEN ASPECT" is set to "16:9", it is possible to project 4:3 video signals on the entire screen without losing any part of the image off screen. It is also possible to adjust the projected image vertically as described in the next section. See "SCREEN ASPECT" in the menu group ④ <SETUP> described on page 17.

■ Adjusting with "DIGITAL LENS SHIFT"

When "SCREEN ASPECT" in the menu group ④ <SETUP> on the menu is set to "16:9", the projected image can be vertically adjusted within the range shown on the right by digitally changing [H] (the height from the lens center to the screen bottom). See page 17.

Screen size (inch)	Height to the screen bottom [H] (cm)	Height to the screen bottom [H] (inch)
60	19—44	7-1/2— 17-5/16
80	26—59	10-1/4— 23-1/4
100	32—74	12-5/8— 29-1/8
120	39—89	15-3/8— 35
150	49—111	19-3/8— 43-3/4
200	65—145	25-5/8— 57

Installation methods

1. Installing on a tabletop

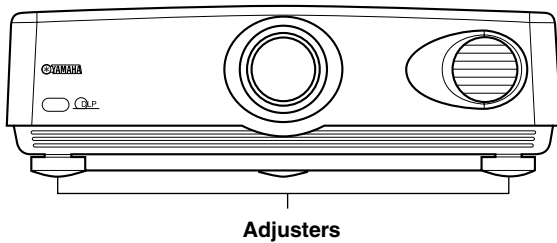
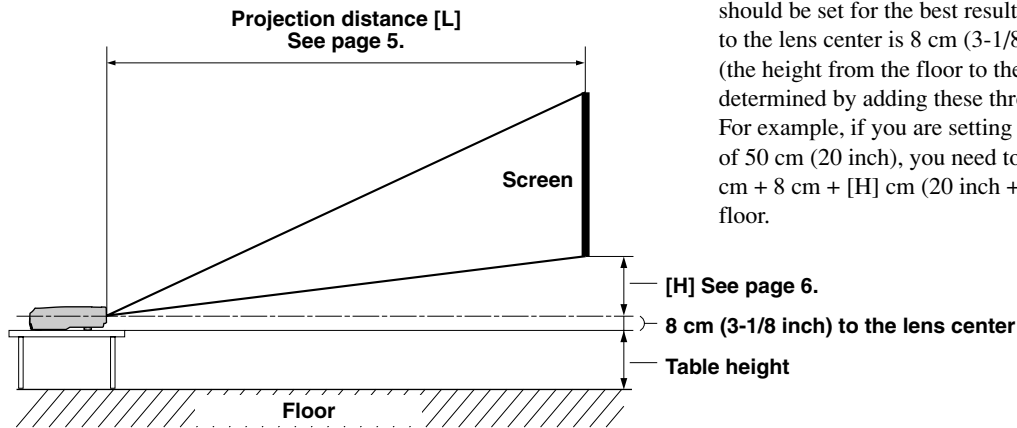

This unit projects images when set on a tabletop with a certain height in front of the screen. The table height and [H] described on page 6 must be determined first to decide on how high the screen should be set for the best result. The height from this unit's bottom to the lens center is 8 cm (3-1/8 inch). The position of the screen (the height from the floor to the screen bottom) can be easily determined by adding these three figures. For example, if you are setting this unit on a tabletop with a height of 50 cm (20 inch), you need to set your screen at a height of $50\text{ cm} + 8\text{ cm} + [H]\text{ cm}$ (20 inch + 3-1/8 inch + [H] inch) from the floor.

[H] See page 6.

8 cm (3-1/8 inch) to the lens center

Table height

Adjusting with the adjusters

When this unit is installed on a tabletop, the position of the image can be adjusted by using the adjusters located at the bottom front of this unit.

Adjust the height by rotating the movable part of the two screw-type adjusters at the front bottom of this unit. The adjustment range of these adjusters is 2.5 cm (1 inch). If loosened completely, they will come off.

2. Mounting on the ceiling

Important

- Never attempt to mount this unit on the ceiling by yourself. Consult with your local authorized dealer or any reliable contractor.

A ceiling mount bracket (optional) is needed for mounting this unit on the ceiling.

The vertically reversed illustration of the screen installation position shown page 6 helps determine how far the screen should be set from the ceiling. The height can be determined by adding [H] described on page 6 and the height of the ceiling mount bracket [C] as shown in the following illustration. When this unit is installed on the ceiling, "FRONT/CEILING" in the menu group ④ <SETUP> must be selected on the menu. (See page 17.) The projected image can be vertically adjusted within a certain range by changing the value in "DIGITAL LENS SHIFT" on the menu when "SCREEN ASPECT" on the menu is set to "16:9". See page 6 for details.

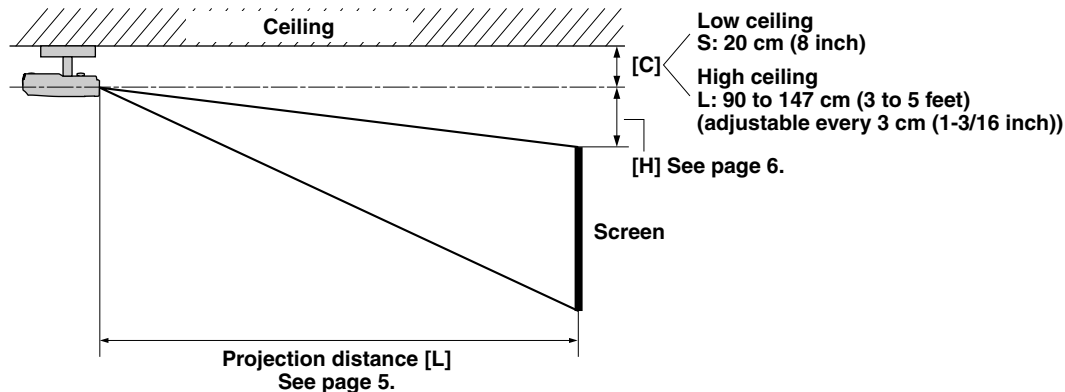

3. Rear projection

You can watch images projected on the back of a semi-translucent screen while sitting on the other side of the screen. The screen position can be determined by simply following the front setting procedures described above. For this setting, "REAR/TABLE" or "REAR/CEILING" must be selected for "INSTALLATION" in the menu group ④ <SETUP> on the menu. (See page 17.)

How to connect

- Before making connections, make sure that the power of this unit and other components is turned off.
- Some components require different connection methods and have different jack names. Refer to the operation instructions for each component to be connected to this unit.
- Plug in this unit correctly to prevent from creating noise or troubles.

■ Connecting a video component

There are five types of video connections available on this unit for A/V components as shown in the illustration below. Connect video output signals from A/V components to this unit by following the illustration below with the correct cables and adapters.

Input	Type of signal	Type of jack
VIDEO	Composite video	Pin jack
S VIDEO	S video	Mini DIN jack
INPUT A	Component video/RGB video	BNC jack x 3—5
INPUT B	Component video/RGB video	D-Sub 15-pin connector
D4 *	Component video	D4 connector

* This connector is designed for the Japanese D format only.

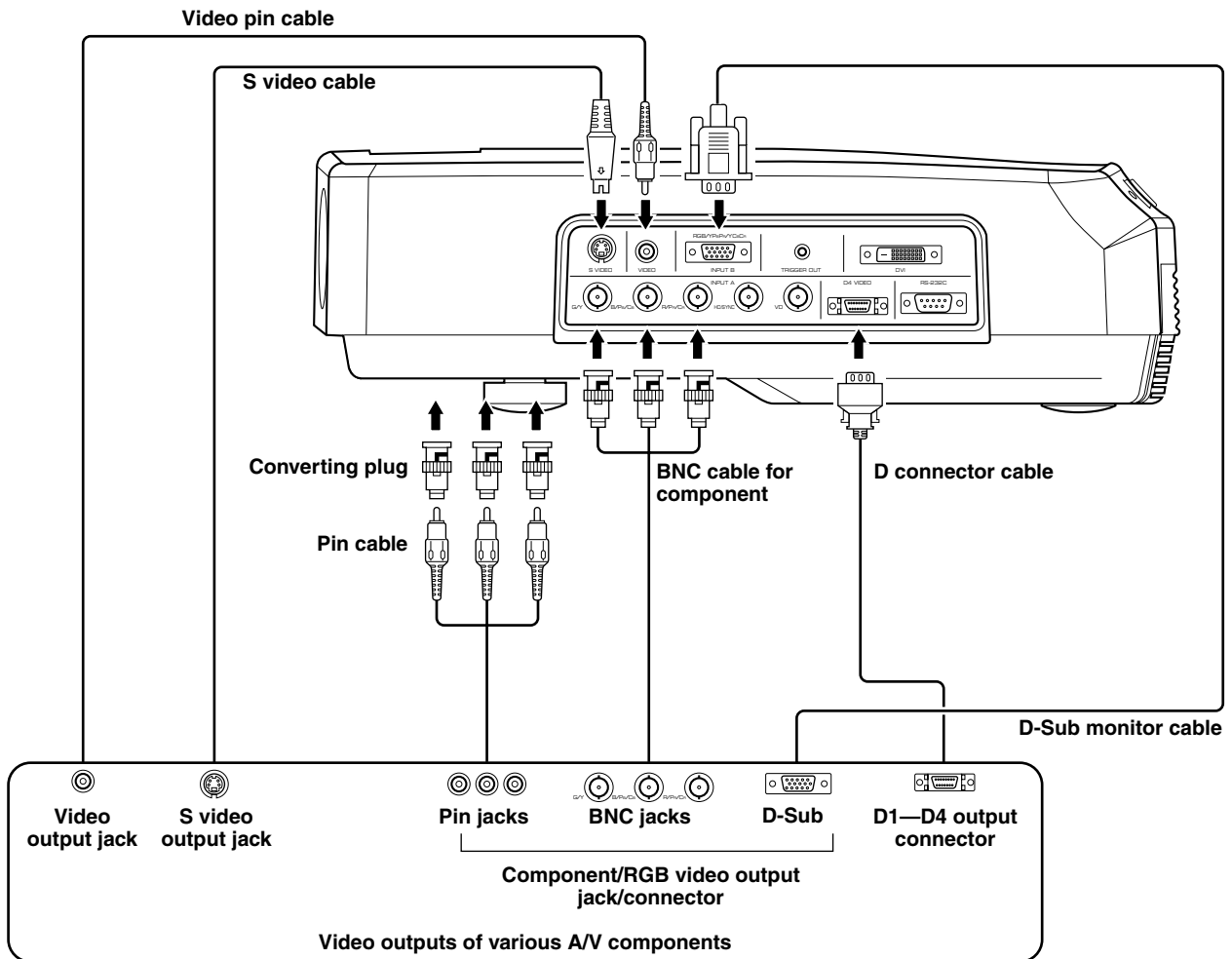

◆ Note ◆

- When connecting A/V component to INPUT A component jacks, make sure to match the Y/P_B/P_R or Y/C_B/C_R of the A/V component and this unit to be connected. Also refer to the operation instructions for the A/V component. HD/SYNC and VD need to be connected for RGB video signals in some cases.

■ Connecting a computer

There are three types of terminals to connect this unit to a computer as listed below. Use the correct cables for the terminals to be connected.

Input	Type of signal	Type of jack
INPUT A	RGB analog	BNC jack x 5
INPUT B	RGB analog	D-Sub 15-pin connector
DVI	RGB digital	DVI connector

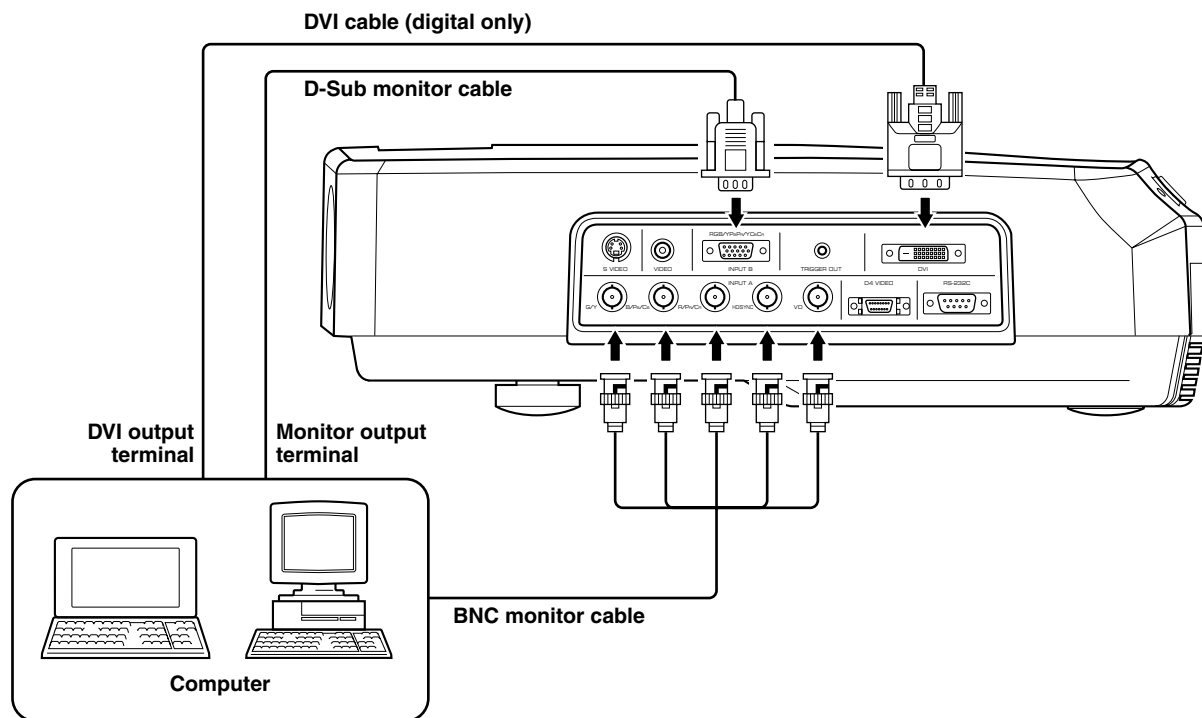

◆ Note ◆

- See ② <SIGNAL> on the menu described on page 16 for setting the type of image input signal.

Using this unit

This section describes the basic projecting operation after installation and connection have been completed. Detailed settings must be made for installation, screen, input signal and so on, by following the menu setting procedure described in the section starting on page 15.

■ Turning on the power

Remove the lens cap before starting any operation of this unit.

1. Plug the supplied power cord into the AC inlet on the rear of this unit. Then plug the cord into the wall outlet.

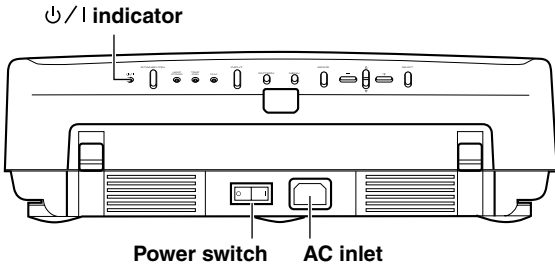

2. Turn on the power switch of this unit. The ⏻/| indicator lights up in red in a few seconds.
3. Press the **STANDBY/ON** button, the ⏻/| indicator flashes in green and the lamp inside this unit lights up.

The ⏻/| indicator stops flashing and lights steadily after about 30 seconds and this unit is ready for projection.

⏻/| indicator
(Flashing in green → lights steadily in green)

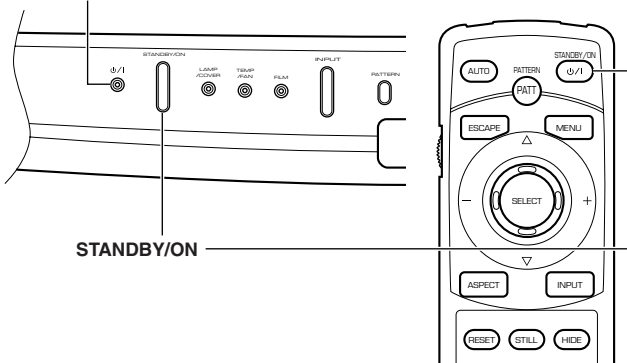

Important

- Never turn off the power switch or unplug this unit while the ⏻/| indicator is lit or flashing in green. This causes significant damage to the lamp and may result in its shorter life or failure.

■ Focusing

Press the **PATTERN** button to project the stored test pattern. Adjust the lens so that it comes into focus by rotating the focus ring. The image size can be also adjusted with the zoom ring.

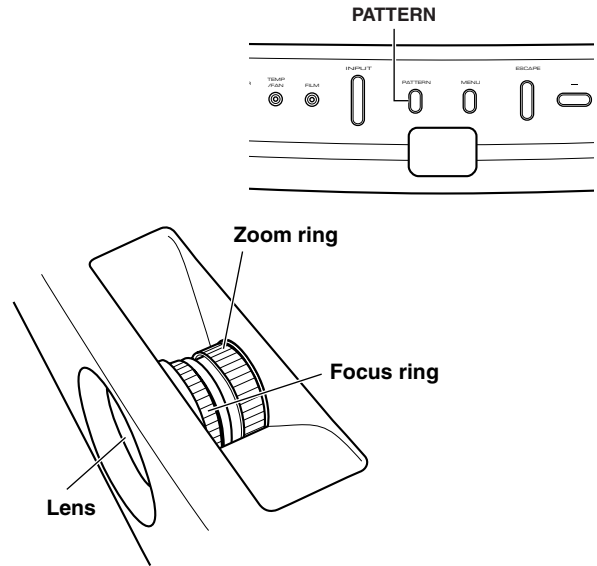

There are two test patterns. Choose whichever is desired by pressing the + or - button.

Press the **PATTERN** button again to close the test pattern.

■ Selecting the input source

Press the **INPUT** button to display the menu for input signals on the screen. Select the input terminal and the input signal to be projected by pressing the Δ or ∇ button, and confirm the selection by pressing the **SELECT** button.

Input Source	Signal to be projected
VIDEO	Composite video signals input from an A/V component to the VIDEO jack
S VIDEO	S video signals input from an A/V component to the S VIDEO jack
INPUT A <COMPONENT>	Component signals input to INPUT A (BNC jacks)
INPUT A <RGB PC>	RGB signals input from a computer to INPUT A (BNC jacks)
INPUT A <RGB TV>	RGB signals input from an A/V component to INPUT A (BNC jacks)
INPUT B <COMPONENT>	Component signals input to INPUT B (D-Sub 15-pin connector)
INPUT B <RGB PC>	RGB signals input from a computer to INPUT B (D-Sub 15-pin connector)
INPUT B <RGB TV>	RGB signals input from an A/V component to INPUT B (D-Sub 15-pin connector)
DVI	Digital RGB signals input from a computer to the DVI connector
D4 VIDEO	Component signal input from an A/V component to the D4 VIDEO connector

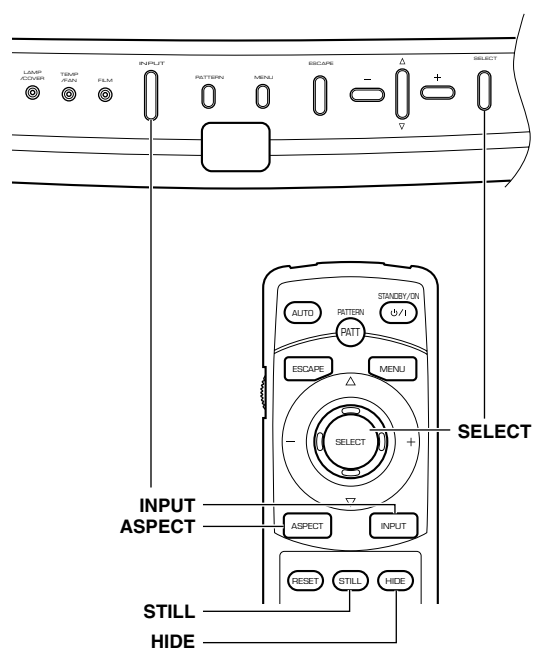

◆ Notes ◆

- When an ordinary video signal or an interlaced video signal of a 24-frame/second film is input, the interlace/progressive (i/p) conversion circuit built into this unit automatically identifies the type of signals. If the signals of a film is input, the FILM indicator lights up in blue. Some contents cannot be correctly detected.
- When the interlaced video signals of a film is input, this unit detects it and the FILM indicator lights up in blue.
- When the signal from an A/V component or computer is input, it does not go through i/p conversion, and the FILM indicator does not light up in this case.
- This unit is compatible with VGA, SVGA, XGA, and SXGA for the RGB signal from a computer. It is recommended to set to XGA to enjoy clearer images when the screen aspect ratio is set to "4:3".
- When this unit is set to display the output signals on both the LCD of a notebook computer and on an external monitor, the image may not be correctly displayed on the external monitor. In this case, set this unit to display on only the external monitor. Refer to the operation instructions of the computer for details.
- Press the **AUTO** button located on upper left on the remote control if the image is not correctly projected (black or distorted images) when the input signal is switched.

■ STILL—freezing the image

Press the **STILL** button on the remote control to capture the desired frame of a moving image. This function can be effectively used to adjust the image quality. Press the **STILL** button again to resume normal projection.

■ HIDE—turning off the image temporarily

Press the **HIDE** button on the remote control to turn off the image temporarily. Press the **HIDE** button again to bring back the image that has been turned off.

- VGA, XGA, and SXGA are trademarks of International Business Machines Corporation.
- SVGA is a trademark of Video Electronics Standards Association.

■ Selecting “ASPECT”

“ASPECT” selects the most appropriate way of displaying the image on the screen for the six common types of signals listed below. Available parameters for “ASPECT” change depending on the “SCREEN ASPECT” setting. This unit has the “AUTO” mode which automatically detects the type of signals and changes the display aspect. This mode is effective when information about the signal type is included in the signal.

Press the **ASPECT** button for the desired display aspect.

- ① Video signal of the 4:3 screen aspect from ordinary TV or video
- ② Letterbox video signal
- ③ Squeezed video signal (Vista size)
- ④ Squeezed video signal (Cinema scope size)
- ⑤ Hi vision (HDTV) 16:9 video signal
- ⑥ RGB signal

● Available aspect modes when “SCREEN ASPECT” is set to “4:3”

① AUTO

When the input signal is letterbox or squeeze, this mode detects it and automatically switches to the most appropriate mode. This mode is effective only when the signal is sent with information about its type.

② NORMAL

This mode projects the image horizontally in full on the screen without cutting any input signal.

③ SQUEEZE

This mode desqueezes the video which has been recorded as horizontally squeezed. The image is projected in the original format after having passed through this circuit.

④ ZOOM

The central part of the image is scaled up. Both sides of the input image lie offscreen.

⑤ THROUGH

The signal is projected as it is input without scaling up or down.

⑥ THROUGH -SQUEEZE-

This mode scales up only the width of the image without changing the height.

[Examples]

Input signal	Input image	Aspect	Projected image
Normal 4:3 image		NORMAL	
Letter box		ZOOM	
		NORMAL	
Squeeze (Vista size)		SQUEEZE	
		THROUGH -SQUEEZE-	
Squeeze (Cinema scope size)		SQUEEZE	
		THROUGH -SQUEEZE-	
HDTV		NORMAL	
		ZOOM	
RGB PC		THROUGH	
		NORMAL	

● Available aspect modes when “SCREEN ASPECT” is set to “16:9”

① AUTO

When the input signal is in letterbox or squeeze, this mode detects it and automatically switches to the most appropriate mode. This mode is effective only when the signal is sent with information about its type.

② NORMAL

This mode projects the image vertically in full on the screen without cutting any input signal.

③ SQUEEZE

This mode desqueezes the video which has been recorded as horizontally squeezed. The image is projected in the original format after having passed through this circuit.

④ ZOOM

This mode projects the signal input as letterbox on the entire screen of 16:9 aspect ratio.

⑤ ZOOM -SUBTITLE-

This mode projects the video in letterbox with subtitles on the screen most appropriately.

“ZOOM -SUBTITLE-” in “ASPECT” in the menu group ② <SIGNAL> has the following two items. See -Exception- on page 20 for the adjustment procedure.

- SUBTITLE AREA
adjusts the subtitle area.
- V SCROLL
adjusts the subtitle position by vertically scrolling the projected image.

⑥ THROUGH

The signal is projected as it is input without scaling up or down.

⑦ THROUGH -SQUEEZE-

This mode scales up only the width of the image without changing the height.

[Examples]

Input signal	Input image	Aspect	Projected image
Normal 4:3 image		→ NORMAL →	
Letter box		→ ZOOM →	
		→ ZOOM -SUBTITLE- →	
Squeeze (Vista size)		→ SQUEEZE →	
		→ THROUGH -SQUEEZE- →	
Squeeze (Cinema scope size)		→ SQUEEZE →	
HDTV		→ NORMAL →	
RGB PC		→ NORMAL →	

■ Turning off this unit

1. When you have finished using this unit, press the **STANDBY/ON** button.

There will be a message to confirm turning off this unit. Press the **STANDBY/ON** button again to turn off this unit. The lamp turns off and the ϕ/I indicator flashes in orange while the fan is rotating to cool the lamp for approximately two minutes.

This unit cannot be turned back on by pressing the **STANDBY/ON** button in this state.

ϕ/I indicator (flashes)

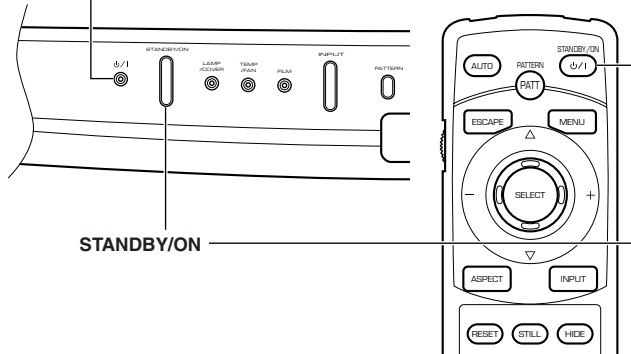

2. When the lamp has cooled down, the ϕ/I indicator stops flashing and steadily lights in red.

3. Turn off the power switch after making sure that the fan has completely stopped and that the ϕ/I indicator is lit in red.

Important

- While the fan is rotating and the ϕ/I indicator is flashing in orange, never turn off the power switch or unplug this unit. This will cause significant damage to the lamp and may result in its shorter life or failure.

■ Indicators

There are four indicators on this unit to display the operating status of this unit.

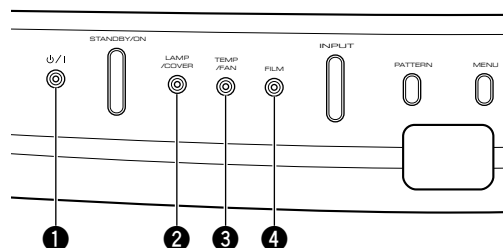

1 ϕ/I

Off	The power is turned off.
Lights in red	In the standby mode
Flashes in green	Getting ready to start operation
Lights in green	Operating
Flashes in orange	Cooling the lamp

2 LAMP/COVER

Off	Normal
Lights in red	The lamp cover is not correctly attached.
	The air filter cover is not correctly attached.

Flashes in red (1-second intervals)

The lamp usage has exceeded 1000 hours.

Flashes in red (0.5-second intervals)

The lamp usage has exceeded 1100 hours.

The lamp has burnt out.

3 TEMP/FAN

Off	Normal
Lights in red	The temperature inside this unit is abnormally high.
Flashes in red	The cooling fan is out of order.

4 FILM

Lights in blue	This unit has detected the interlaced signal (480i) of 24-frame/second film and is converting it to progressive images.
Off	Video signals other than the interlaced signal (480i) of 24-frame/second film are being input.

Menu structure

It is necessary to make various settings on the menu so that this unit can achieve the best performance. The menu has a three-level hierarchy; menu group, menu item, and submenu for some menu items. Listed below are the four menu groups.

- ① <IMAGE> To adjust the image quality. Available items depend on the type of input signal.
- ② <SIGNAL> To make settings for the connected input signal. Available items depend on the type of input signal.
- ③ <INITIAL> To make your own initial setting for several menu items.
- ④ <SETUP> To make settings for installation, screen aspect, key stone effect correction and so on.

Each menu group described above consists of the following items. The parameters for these items can be adjusted as you wish by following the menu operation procedures described from page 18.

S means that the item has a submenu.

■ ① <IMAGE> Adjustment cannot be made without any input signal.

Input signal	Menu item	Adjustment range
Video/Component/ RGB TV	BLACK LEVEL Adjusts the level of blackness while maintaining the peak white brightness.	-64 to 32
Video/Component/ RGB	CONTRAST The ratio of light versus dark. If increased too high, the whole image becomes light and the white portion of the image tends to be saturated. If decreased too low, the whole image becomes dark and flat.	-128 to 127
Video/Component/ RGB	BRIGHTNESS Controls the total brightness of an image. When adjusted too high, the black portion of the image becomes grayish and the white portion of the image tends to be saturated. When adjusted too low, the entire image becomes darker.	-128 to 127

The three menu items described above are to adjust the input and output characteristics for the image brightness of the luminance signal. The graphs below show how these items can be adjusted.

BLACK LEVEL

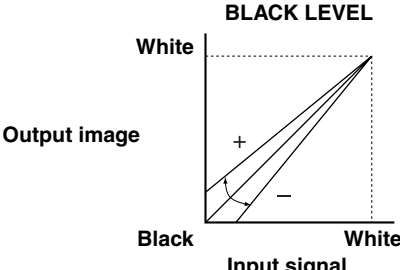

CONTRAST

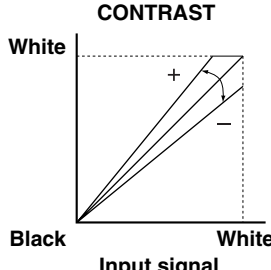

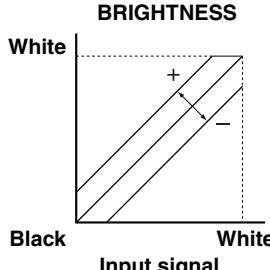

BRIGHTNESS



Video/Component/ RGB	GAMMA TRIM Adjusts the response of the color gradation and gray-scale of the image. There are five patterns available. Select the appropriate pattern depending on the content to be projected.	A/B/C/D/E
Video/Component/ RGB	SHARPNESS Adjusts the clearness of the image edges. The higher value creates clearer edges. The lower value creates a softer image with the less noise element.	1 to 5
Video	HUE Adjusts the hue. When adjusted to the negative direction, red increases. When adjusted to the positive direction, blue increases. (Adjustment at the SECAM setting is not effective.)	-128 to 127
Video	SATURATION Adjusts the depth of a color. When adjusted to the negative direction, the color becomes lighter. When adjusted to the positive direction, the color becomes deeper.	-128 to 127
Component	COLOR BOOST Boosts the color saturation. The higher value makes the color tends to be saturated and becomes deeper.	0 to 127
Video/Component/ RGB	COLOR TEMP Adjusts the color of the image to be projected. The higher setting adds more blue and the lower setting adds more red. Select the appropriate setting depending on the content to be projected.	LOW/MID-L/MID/HIGH
Video/Component/ RGB	WHITE BALANCE S Fine-adjusts the balance of each color (R, G, B). CONTRAST (R, G, B) BRIGHTNESS (R, G, B)	50% to 124% -12.4% to 12.4%
Video/Component/ RGB	WHITE BOOST Optically adjusts the luster of the white part of the projected image.	0 to 10

Menu structure

■ ② <SIGNAL> Adjustment cannot be made without any input signal.

Input signal	Menu item	Choice/adjustment range
Video/Component/RGB	ASPECT  <p>Sets the aspect ratio of displaying the image on the screen. "AUTO" automatically switches to the most appropriate mode. "NORMAL" (THROUGH) projects the image as the input signal is sent. "SQUEEZE" desqueezes the squeezed image. "ZOOM" projects the image scaled up with a certain ratio. "ZOOM -SUBTITLE-" displays the subtitle. "THROUGH -SQUEEZE-" displays the image with its width scaled up. Available items depend on the "SCREEN ASPECT" setting and the type of input signals.</p> <p>The "AUTO" setting may not switch to the most appropriate mode for some sources. If it doesn't, make a setting manually.</p> <p>"ZOOM -SUBTITLE-" has further items to be adjusted SUBTITLE AREA: adjusts the subtitle area. V SCROLL: adjusts the subtitle position by vertically scrolling the projected image.</p>	AUTO/NORMAL/ SQUEEZE/ZOOM/ZOOM -SUBTITLE-  (SUBTITLE AREA, V SCROLL)/THROUGH/ THROUGH -SQUEEZE-
Video/Component	SUBTITLE MASK Darkens the brightness of the characters in the subtitles when playing the film in letterbox with subtitles (except for HDTV).	OFF/ON
Video/Component	MASK POSITION Changes the effective height for the "SUBTITLE MASK" adjustment (except for HDTV).	-10 to 10
Video	3D Y/C SEPARATION Suppresses the rainbow-like color crossing the image of fine vertical stripes or annoying dot interference on the image edge when the video signal is input. This adjustment is available only for the composite signal in NTSC mode.	ON/OFF
Video/Component	NOISE REDUCTION Effectively reduces the noise included in the luminance signal and color signal by digital processing when playing the source with a relatively large amount of noise in order to create a more vivid image (interlaced signal only, except for HDTV).	OFF/1/2/3
Video	VIDEO TYPE Selects VCR when playing video tapes in order to ensure synchronization, and selects DVD when playing other sources.	DVD/VCR
Video/Component	SETUP LEVEL Adjusts the black level difference of the image signal. Select 0% for a signal with no difference from the pedestal level, and 7.5% for a signal with higher black level.	0%/7.5%

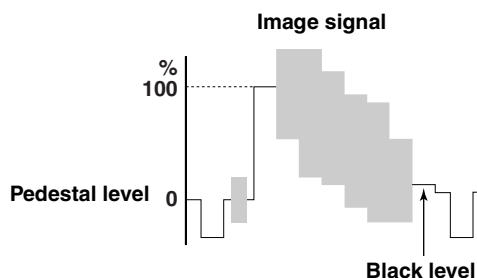

RGB	DOT PHASE Fine-adjusts the phase of the RGB signal input from the computer for clearest display of the characters and lines of the image (except for DVI).	0 to 31
RGB	SIZE H Adjusts the horizontal size of the projected image (except for DVI).	-2047 to 2048
RGB	SHIFT H Adjusts the horizontal position of the projected image (except for DVI).	0 to 100
RGB	SHIFT V Adjusts the vertical position of the projected image (except for DVI).	0 to 100
RGB	SIGNAL STATUS Displays the resolution and sync. frequency of the input signal.	—

■ ③ <INITIAL>

Menu item	Choice
COLOR SYSTEM	AUTO/NTSC/NTSC4.43/PAL/PAL-M/PAL-N/PAL60/SECAM
Selects the color system when the video signal is input among NTSC, NTSC4.43, PAL, PAL-M, PAL-N, PAL60, SECAM. AUTO should normally be selected so that the appropriate color system can be automatically selected depending on the input signal. However, PAL-M should be selected when the input signal is PAL-M.	
INPUT A SIGNAL	COMPONENT/RGB PC/RGB TV
Selects the type of input signal sent to the INPUT A jacks.	
INPUT B SIGNAL	COMPONENT/RGB PC/RGB TV
Selects the type of input signal sent to the INPUT B jacks.	
LANGUAGE	日本語/ENGLISH/DEUTSCH/ESPAÑOL/FRANÇAIS/ITALIANO/中文
Selects the language used on the menu.	
POWER SAVING	OFF/ON
When no signal is received at the input jacks for longer than 15 minutes, this unit automatically turns off the lamp and enters the standby mode if ON is selected.	
LAMP RUNNING TIME	—
Displays the total lamp running time. The lamp running time can be reset on the submenu.	
RESET	ALL SETTINGS/ALL MEMORIES/CURRENT MEMORY
Resets all parameters on the menu or parameters in the memory to the factory settings.	

■ ④ <SETUP>

Menu item	Choice/adjustment range
INSTALLATION	FRONT/TABLE, FRONT/CEILING, REAR/TABLE, REAR/CEILING
There are four methods to install this unit; tabletop or on-ceiling for front or rear projection. The image can be inverted or rotated according to the setting for the installation method.	
SCREEN ASPECT	4:3/16:9*
Selects 4:3 or 16:9 depending on the screen to be used. If 16:9 is selected, vertical adjustment of the image can be made by changing the value of the item "DIGITAL LENS SHIFT". And automatically makes an adjustment to project the 4:3 input signal without losing any part of it off screen.	
* DIGITAL LENS SHIFT	-96 to 96
The image on the screen can be vertically adjusted within a certain range by digital processing. Δ moves the image upward and ∇ downward. This adjustment is available only when the screen aspect ratio is set to 16:9.	
KEYSTONE	-128 to 127
If this unit projects on a the screen with some elevation or depression angle at its installation, the image on the screen is distorted into a trapezoid. This parameter electrically corrects the distortion. Increase the value when the upper part of the image is wider. Decrease the value when the lower part if the image is wider.	
KEYSTONE MODE	NORMAL/FULL
There are two modes; "FULL" that corrects the key stone effect without changing the vertical length of the image, and "NORMAL" that makes vertical correction by shifting the bottom at the same time. Select the appropriate mode to make correction depending on your installation.	
① Normal correction	② Full correction
This correction shifts the bottom of the projected image to correct the horizontal distortion.	This correction adjusts the horizontal distortion without changing the vertical length of the projected image.
When the upper part of the image is wider than the lower part, increase the value to the positive (+) direction.	When the upper part of the image is wider than the lower part, increase the value to the positive (+) direction.
When the lower part of the image is wider than the upper part, decrease the value to the negative (-) direction.	When the lower part of the image is wider than the upper part, decrease the value to the negative (-) direction.
R/C SENSOR	FRONT&REAR/FRONT/REAR
Sets the remote control sensor to be used. This unit has its remote control sensor in two locations: at the front and the rear.	

MENU

English

Menu operation

Menu screen and operating buttons

This section provides you with general information about the menu screen and operating buttons on the remote control and this unit's control panel for easier operation. Please read it carefully before starting to operate the menu.

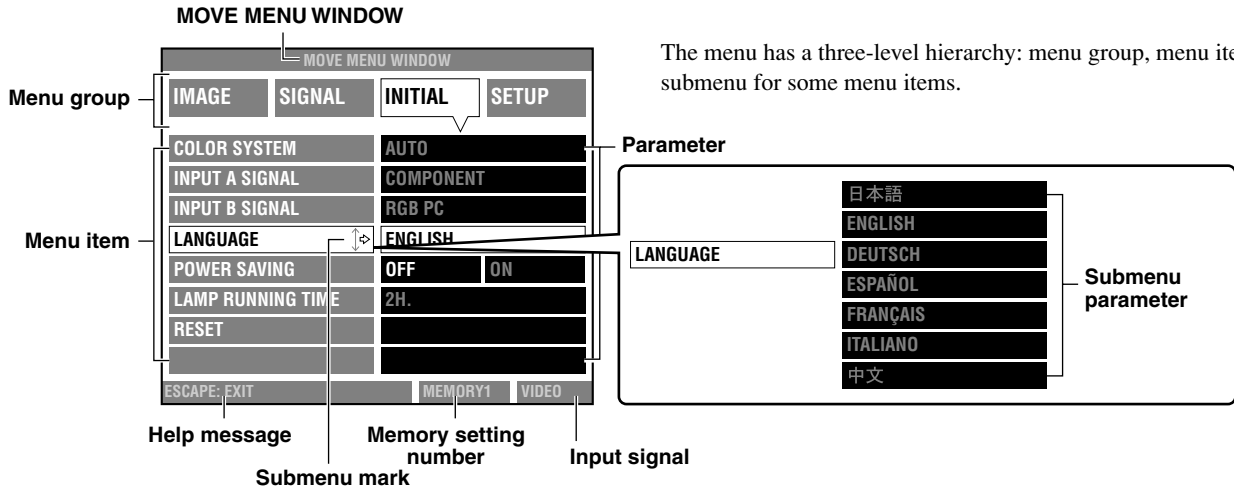

The menu has a three-level hierarchy: menu group, menu item, and submenu for some menu items.

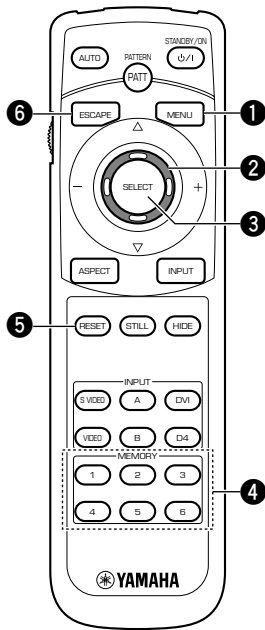

1 MENU button

Opens or closes the menu.

2 Cursor buttons

+/- (for side-to-side movements)

- Select a menu group.
- Open or closes a submenu.
- Select or changes a setting.

△/▽ (for up and down movements)

- Select a menu item.
- Select or changes a setting.

3 SELECT button

- Opens a submenu.
- Confirms a new setting when adjusting "COLOR SYSTEM", "INPUT A SIGNAL", "INPUT B SIGNAL", or R/C SENSOR".
- Opens a one-touch image menu when the menu screen has not been opened.

4 MEMORY 1 to 6 button (Remote control only)

Selects a memory setting number.

5 RESET button (Remote control only)

Resets the parameter setting to the factory setting. Items without factory settings cannot be reset.

6 ESCAPE button

- Returns the cursor to the menu group hierarchy from the menu item hierarchy.
- Returns to the menu from the MOVE MENU WINDOW.
- Closes the submenu.
- Closes the menu when the cursor is on one of the menu groups.
- Closes the one-touch image menu.

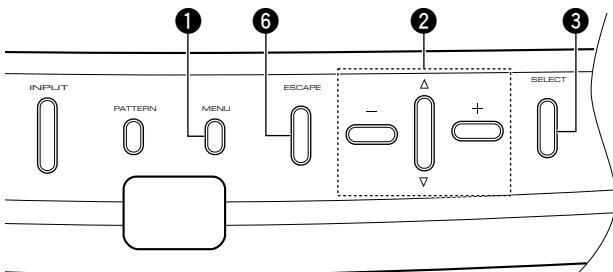

Basic menu operation

To ensure proper projection, start with setting and adjustment for the menu group "SETUP".

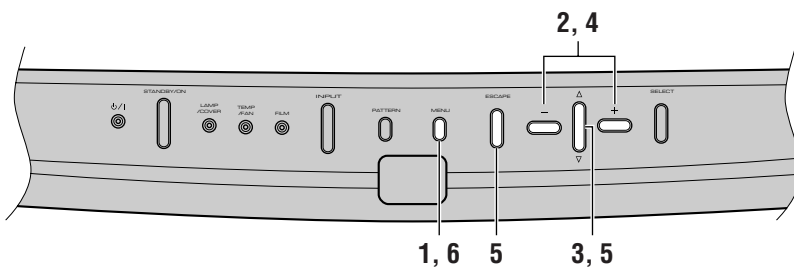
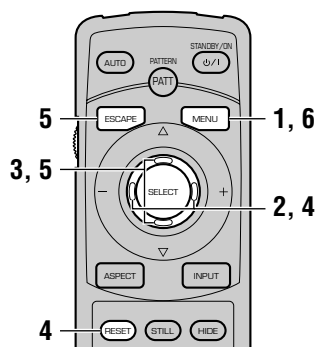

1. Press the MENU button to open the menu.

The previous menu screen opens if menu operation has already been performed.

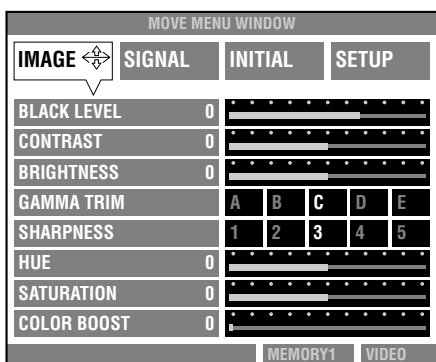
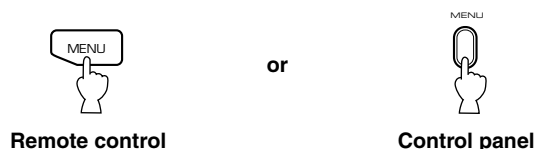

2. Press the + or - button to select a menu group.

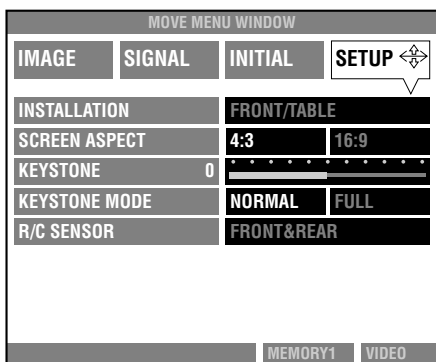
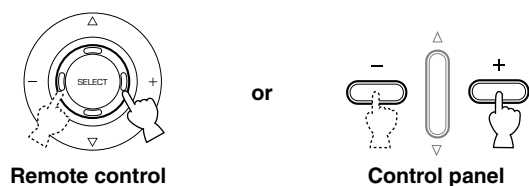

3. Press the Δ or ▽ button to enter the menu item hierarchy.

Then select an item to be adjusted by pressing the Δ or ▽ button.

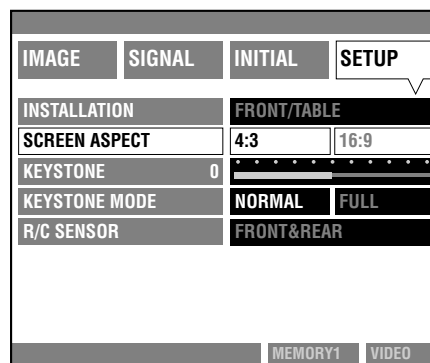
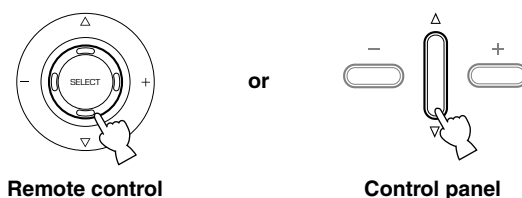

4. Select or change the parameter by pressing the + or - button.

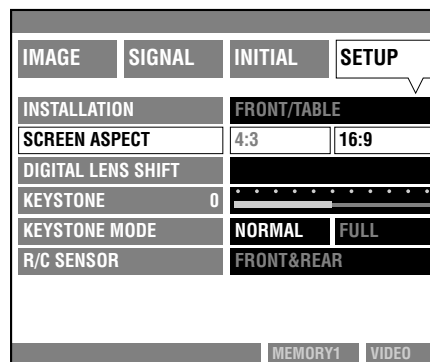
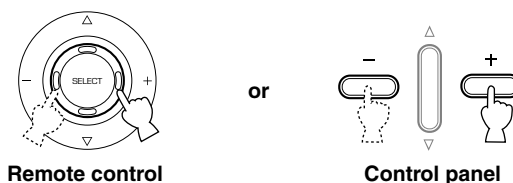

MENU

English

Menu operation

Some items are adjusted by increasing or decreasing the value on the scale, and others by selecting a number or a word.



Press the **RESET** button to reset the parameter to the factory setting. (Items without a factory setting cannot be reset.)

5. Press the Δ or ∇ button to move the cursor to the next item.

First return to the menu group by pressing the **ESCAPE** or Δ button if the next item belongs to the another menu group. Then follow the previous steps 2—4 to continue menu setting.

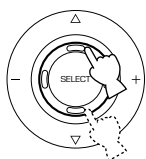

Remote control

or

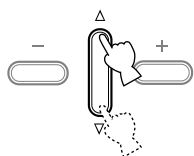

Control panel

6. Press the **MENU** button to close the menu when setting has been completed.



Remote control

or



Control panel

Submenu

Following is a list of the menu items that have a submenu. Submenu operation varies according to the menu item selected. Follow the steps of the applicable submenu operation group.

Menu items with a submenu

Menu group	Menu item	Submenu operation group
IMAGE	WHITE BALANCE	C
SIGNAL	ASPECT*	A
INITIAL	COLOR SYSTEM	B
	INPUT A SIGNAL	B
	INPUT B SIGNAL	B
	LANGUAGE	A
	LAMP RUNNING TIME	D
SETUP	RESET	D
	INSTALLATION	A
	DIGITAL LENS SHIFT	A
	R/C SENSOR	B

Operation group A: Press the **SELECT** or **+** button to open the submenu. Select the desired parameter by pressing the Δ or ∇ button, and then press the **ESCAPE** or **-** button to close the submenu.

Operation group B: Press the **SELECT** or **+** button to open the submenu. Select the desired parameter by pressing the Δ or ∇ button, and then confirm the new setting by pressing the **SELECT** button. After the setting has been confirmed, press the **ESCAPE** or **-** button to close the submenu.

Operation group C: Press the **SELECT** or **+** button to open the submenu. Select the submenu item by pressing the Δ or ∇ button, and then change the parameter by pressing the Δ or ∇ button. It is not necessary to confirm the new setting.

Operation group D: Press the **SELECT** or **+** button to open the submenu, which is in the form of messages. Perform menu operation by following the direction in the message. The submenu for this group is explained in the section on pages 22 and 23.

-Exception-

- * When the menu item “SCREEN ASPECT” in the menu group “SETUP” is set to “16:9”
If “ZOOM -SUBTITLE-” is selected in the submenu for “ASPECT”, there is an additional menu to make your desired setting. Press the **SELECT** button to open the additional menu. There are two items, “SUBTITLE AREA” and “V SCROLL”. Select the item to be adjusted by pressing the Δ or ∇ button. Set the desired value by pressing the **+** or **-** button. Press the **ESCAPE** button to close the additional menu.

Basic submenu operation

[Operation groups A and B]

1. Select the menu item to be adjusted by following steps 1—3 in “Basic menu operation”.

The submenu mark “↔” appears on the right side of the item.

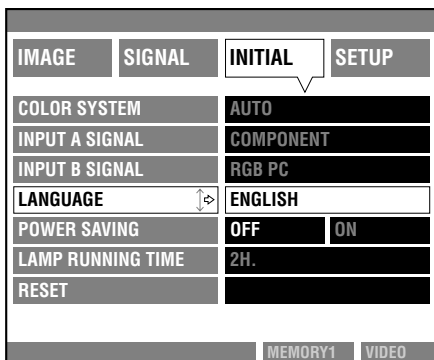

2. Press the **SELECT** or **+** button to open the submenu.

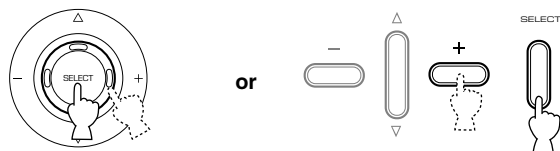

Remote control

Control panel

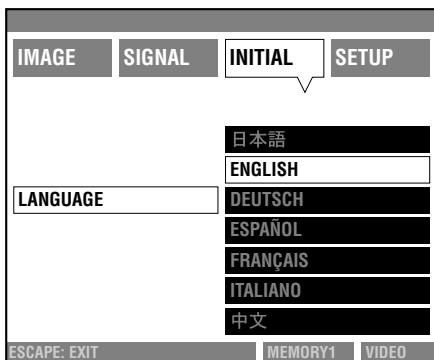

3. Select the submenu parameter by pressing the **△** or **▽** button.

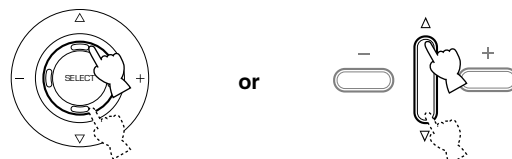

Remote control

Control panel

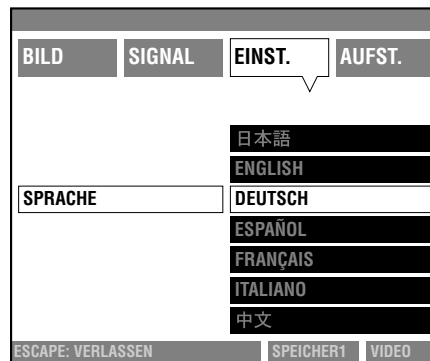

Press the **RESET** button to reset the parameter to the factory setting. (Items without a factory setting cannot be reset.)

When setting “COLOR SYSTEM”, “INPUT A SIGNAL”, “INPUT B SIGNAL”, or “R/C SENSOR”, the following step [Operation group B only] is necessary.

[Operation group B only]

Press the **SELECT** button to confirm the new setting and close the submenu. Setting cannot be changed for the above items if not confirmed by the **SELECT** button.

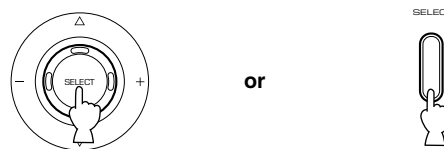

Remote control

Control panel

To reset the parameter to the factory setting, press the **RESET** button when the submenu has been opened.

4. Press the **MENU** button to close the menu.

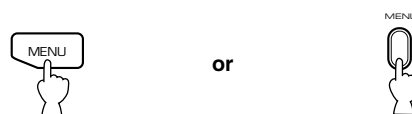

Remote control

Control panel

Press the **ESCAPE** or **–** button to return to the previous screen if continuing to adjust settings.

Menu operation

● Submenu operation—“WHITE BALANCE”

[Operation group C]

1. Select the menu item “WHITE BALANCE” in the menu group “IMAGE” by following steps 1—3 in “Basic menu operation”.

The submenu mark “↔” appears on the right side of the item.

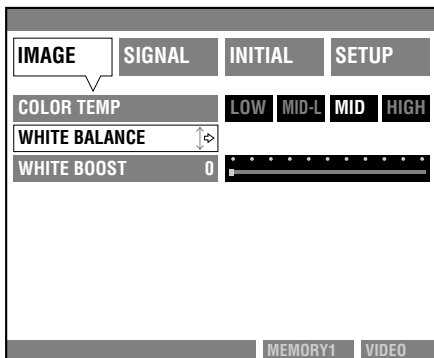

2. Press the SELECT or + button to open the submenu.

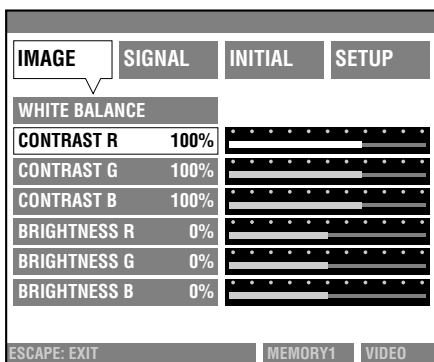

3. Select the submenu item by pressing the △ or ▽ button.

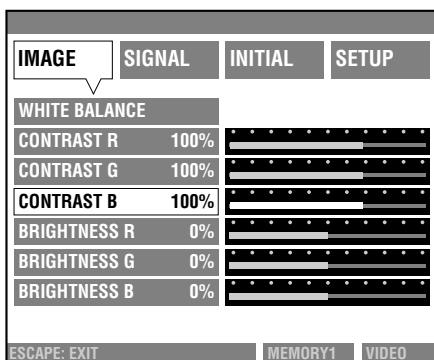

4. Select the value by pressing the + or – button.

Press the **RESET** button to reset the parameter to the factory setting.

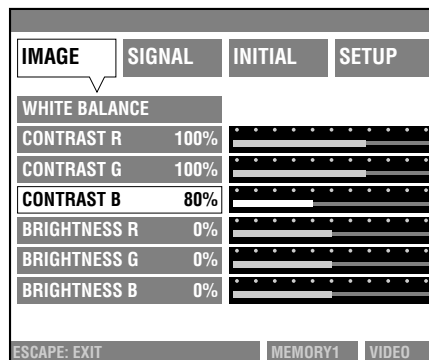

5. Press the MENU button to close the menu.

Press the **ESCAPE** button to return to the previous screen if continuing to adjust settings. The – button does not close the submenu to return to the previous screen for this parameter.

● Submenu operation—“LAMP RUNNING TIME”

[Operation group D]

1. Select the menu item “LAMP RUNNING TIME” in the menu group “INITIAL” by following steps 1—3 in “Basic menu operation”.

The submenu mark “↔” appears on the right side of the item.

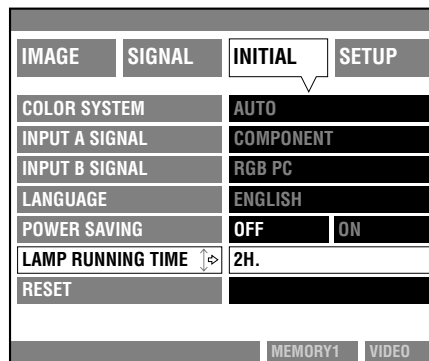

2. Press the SELECT or + button to open the confirmation message screen.



3. Select "YES" by pressing the Δ or ∇ button, and then press the SELECT button to reset the lamp running time to 0.

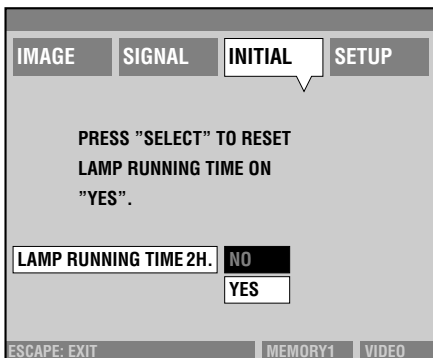

4. Press the MENU button to close the menu.

● Submenu operation—"RESET"

[Operation group D]

1. Select the menu item "RESET" in the menu group "INITIAL" by following steps 1—3 in "Basic menu operation".

The submenu mark " \updownarrow " appears on the right side of the item.

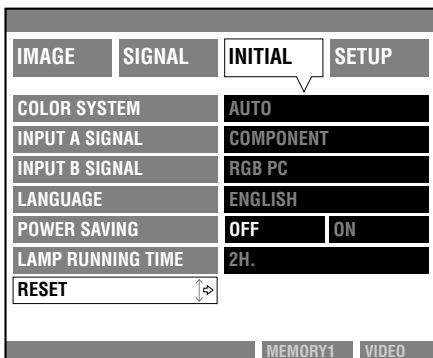

2. Press the SELECT or + button to open the submenu.

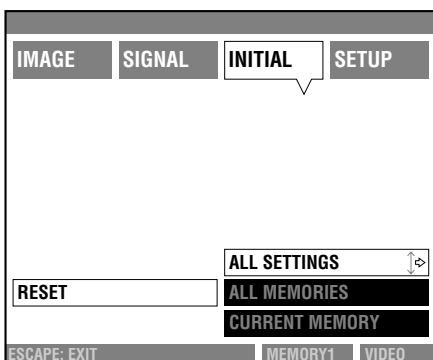

3. Select the submenu item to be reset by pressing the Δ or ∇ button.

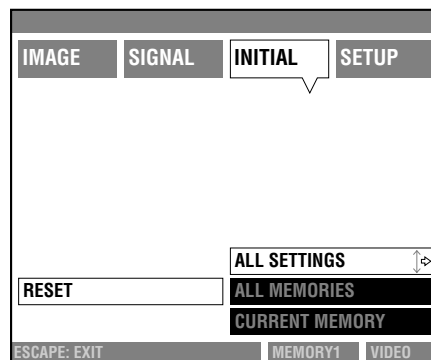

4. Press the SELECT or + button to open the confirmation message screen.



5. Press the SELECT button to reset to the factory setting.

The menu closes after the parameters have been reset to the factory settings.

■ One-touch image menu

1. Press the **SELECT** button to open the one-touch image menu when the menu has not been opened.

The image menu items appear at the bottom of the screen one after another. The previous parameter appears once menu operation has been performed.

The displayed item turns off if no operation is performed within five seconds.

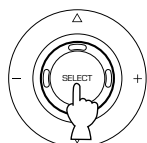

Remote control

SELECT



Control panel



2. Select the item to be adjusted by pressing the Δ and ∇ button.

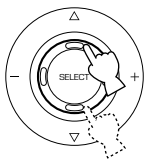

Remote control

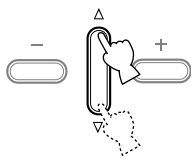

Control panel

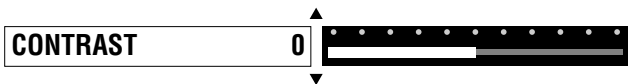

3. Select the value by pressing the + or - button.

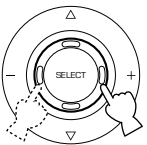

Remote control

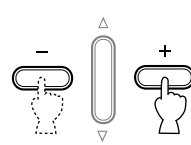

Control panel

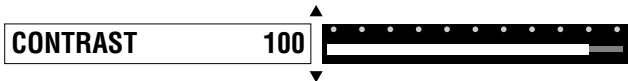

Press the **RESET** button to reset the parameter to the factory setting.

4. Press the **SELECT** or **ESCAPE** button to close the one-touch menu.

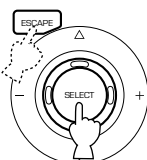

Remote control



Control panel

■ Changing the menu location

1. Press the **ESCAPE** or Δ button to return the cursor to the menu group.

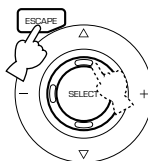

Remote control

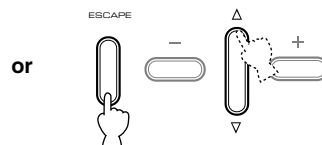

Control panel

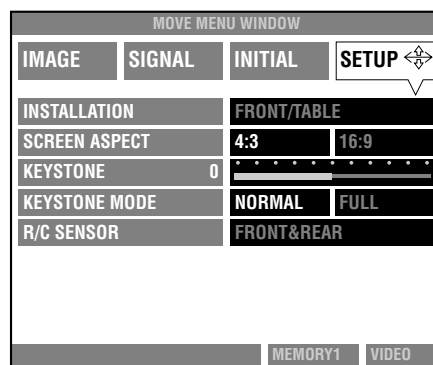

2. Press the Δ button to enter the "MOVE MENU WINDOW".

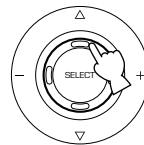

Remote control

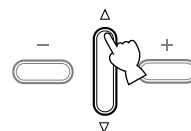

Control panel

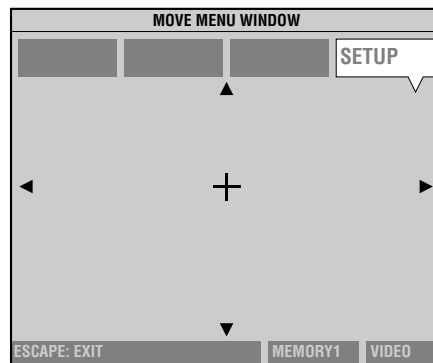

3. Change the location of the menu by pressing the +, -, Δ , or ∇ button.

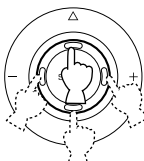

Remote control

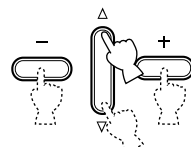

Control panel

4. Press the **ESCAPE** button to return to the menu after the location has been decided.



Remote control



Control panel

Memory function

This unit has a memory function that can store six settings to project different types of input sources in the most appropriate manner. Select one of these six settings that is most suitable for your projection. Although six settings have already been prepared, each parameter in the settings can be changed and restored as you wish. The following lists the menu items that can be stored in memory.

IMAGE	SIGNAL
BLACK LEVEL	3D Y/C SEPARATION
CONTRAST	NOISE REDUCTION
BRIGHTNESS	VIDEO TYPE
GAMMA TRIM	SETUP LEVEL
SHARPNESS	
HUE	
SATURATION	
COLOR BOOST	
COLOR TEMP	
WHITE BALANCE	
WHITE BOOST	

■ Selecting the memory setting number

To select by operating the remote control

Press the number of the desired memory setting among the **MEMORY 1—6** buttons.

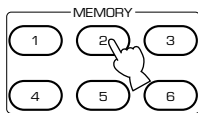

To select by operating the menu

1. Press the MENU button to open the menu.



2. Press the ▽ button to enter the memory setting number at the bottom of the screen.

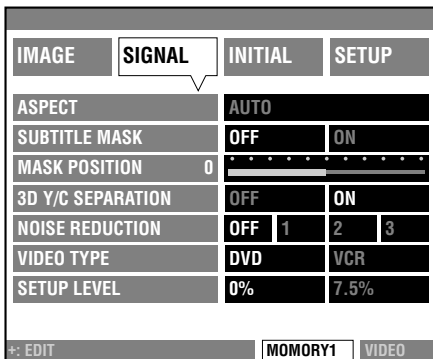
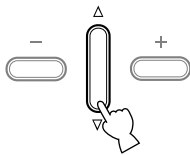

3. Press the + button to open the submenu.

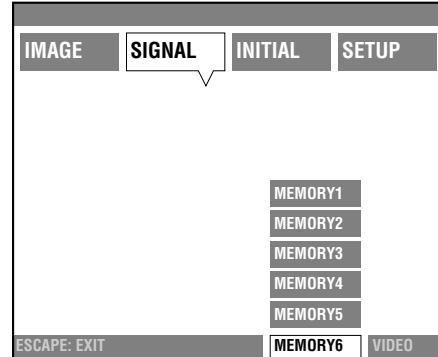
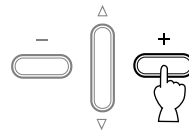

4. Select the desired memory setting number by pressing the △ or ▽ button.

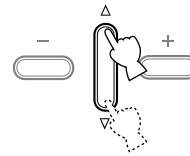

5. Press the ESCAPE button to close the submenu.



■ Resetting to the factory setting

For one parameter

Select the parameter to be reset to the factory setting by following steps 1—3 in “Basic menu operation”. Press the **RESET** button on the remote control to reset to the factory setting. (Items without a factory setting cannot be reset.)

For all parameters in the memory setting being selected

Select “CURRENT MEMORY” on the submenu by following “Submenu operation—RESET” on page 23. Press the **SELECT** or **+** button to open the confirmation message screen. Press the **SELECT** button to reset to the factory setting.

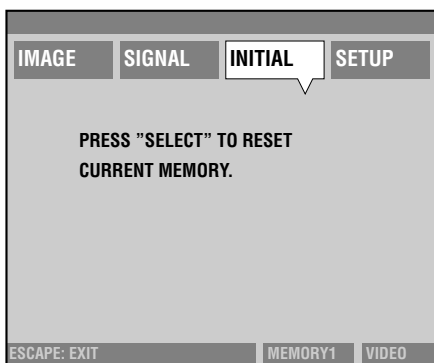
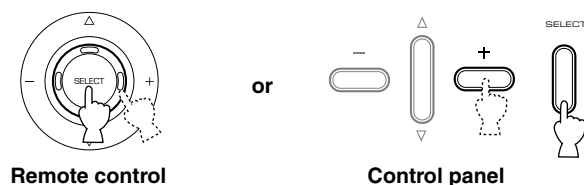

For all parameters in six memory settings

Select “ALL MEMORIES” on the submenu by following “Submenu operation—RESET” on page 23. Press the **SELECT** or **+** button to open the confirmation message screen. Press the **SELECT** button to reset to the factory setting.

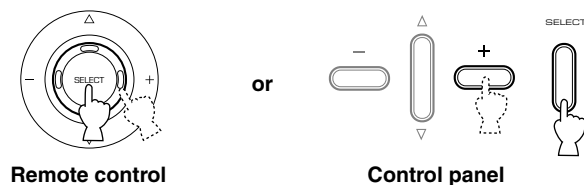

Additional information

■ Glossary

DLP™ technology

This stands for Digital Light Processing. DLP uses the DMD™ optical semiconductor chip developed by Texas Instruments.

Component video signal

This signal is sent with its luminance signal and color signal independent. It creates higher image quality compared with an ordinary composite video signal because it bypasses the mixing and separating circuits. This signal is sent in three lines: the luminance signal (Y) and two color difference signals (Pb/Cb, Pr/Cr).

S video signal

S stands for Separate. This signal is sent with its luminance signal (Y) and color signal (C) separately. A 4-pin mini DIN connector and cable are used for connection.

Composite video signal

This is the most common type of video signal. The luminance signal and color signal are sent combined in one line. Mixing and separating processes are necessary on both the send and receive sides. A pin cable is used for connection.

RGB signal

An RGB signal transmits color information by using a numeric representation of the primary colors of red, green and blue separately. When the signal is received, it can be expressed in various colors by adding and mixing colors. This signal is widely used for sending and receiving color images between computers. Horizontal and vertical sync signals are also necessary.

D connector

* This connector is designed for the Japanese D format only. This connector is used for sending and receiving the image signal between the latest type of A/V components. This connector can receive the component signal by using a D connector cable. There are five levels (D1—D5) of performance characteristics. This unit is compatible with D1, 2, 3, and 4.

DVI connector

A digital RGB signal is sent from a computer to this connector differentially. A 24-pin connector and cable are used for connection.

Standby

The state under which the circuit to receive infrared-signals from the remote control is activated but other main circuits are turned off. A small amount of power is consumed in this state.

Test pattern

Test patterns are stored in this unit to adjust the position and focus of the projected image on the screen.

Aspect ratio (aspect)

This basically means the length-to-width ratio of an image. This unit's menu deals with two kinds of aspect ratio: the screen aspect that sets the length-to-width ratio of the screen to be used, and the display aspect that changes the size and aspect ratio of the images to be projected for different types of input signal.

Ceiling mount bracket

This is the mounting hardware used when hanging this unit from the ceiling. Two types of ceiling mount bracket (low ceiling and high ceiling) are available for different heights of the ceiling. These mounts are optional.

Interlace

The common type of scanning for most televisions. It divides into two fields: even and odd numbered lines of the field to build one frame of an image.

Progressive

This displays all the scanning lines of the entire frame at one time. It greatly reduces the flicker that is more noticeable on a larger screen to create a sharp and smooth image. This unit projects by progressive scanning.

Key stone

If this unit has an elevation or depression angle when projecting on the screen, the image is distorted in a trapezoid. This item electrically corrects the distortion. Two types of correction are available; "Normal correction" and "Full correction".

Letter box

This is the method to convert the content of a film in landscape orientation to 4:3 signal. It is possible to watch the landscape image without trimming by adding a black bar on the top and bottom of the screen. Vertical resolution may be sacrificed to some extent.

Squeeze

This method horizontally squeezes the film so that the aspect ratio is 4:3 when recording the film on a video medium. The squeezed image must be passed through the desqueezing circuit otherwise the image remains in a slender shape.

Vista size

One of the film sizes. The aspect ratio is 1.85:1 in North America and 1.66:1 in Europe.

Cinema scope size

This is the widest film size that uses a 70 mm film. The aspect ratio is 2.35:1.

- DLP™ and DMD™ are trademarks of Texas Instruments.

Additional information

■ Projectable signals

The following charts show the types and formats of the signals that can be projected by this unit. Any signals not listed below may not be properly projected.

1. TV format ① ----- Composite or S video signals sent to the VIDEO or S VIDEO input terminal

Type of signal	V active (lines)	f (v) (Hz)	Color signal (MHz)	Color system
NTSC	480	59.94	3.5795	NTSC
PAL	576	50.00	4.43	PAL
SECAM	576	50.00	4.406, 4.25	SECAM
PAL60	480	59.94	4.43	PAL
NTSC4.43	480	59.94	4.43	NTSC
PAL-M	480	59.94	3.5756	PAL
PAL-N	576	50.00	3.582	PAL

2. TV format ② ----- Component or RGB signals sent to the INPUT A, B, or component signals sent to the D4 input terminal

Type of signal	H active (pixels)	V active (lines)	f (H) (kHz)	f (V) (Hz)
480i	720	483	15.734	59.940
576i	720	576	15.625	50.000
480p	720	480	31.469	59.940
720p	1280	720	45.000	59.940
1035i	1920	1035	33.750	60.000
1080i	1920	1080	33.716	59.940

3. PC format ① ----- Analog RGB signals sent to the INPUT A or B input terminal

	Type of signal	H active (pixels)	V active (lines)	f (H) (kHz)	f (V) (Hz)
VESA	VGA@60Hz	640	480	31.469	59.940
	VGA@72Hz	640	480	37.861	72.809
	VGA@75Hz	640	480	37.500	75.000
	VGA@85Hz	640	480	43.269	85.008
	SVGA@56Hz	800	600	35.156	56.250
	SVGA@60Hz	800	600	37.879	60.317
	SVGA@72Hz	800	600	48.077	72.188
	SVGA@75Hz	800	600	46.875	75.000
	SVGA@85Hz	800	600	53.674	85.061
	XGA@60Hz	1024	768	48.363	60.004
	XGA@70Hz	1024	768	56.476	70.069
	XGA@75Hz	1024	768	60.023	75.029
	XGA@85Hz	1024	768	68.677	84.997
	1152x864@75Hz	1152	864	67.500	75.000
1280x960@60Hz	1280	960	60.000	60.000	
Apple	SXGA@60Hz	1280	1024	63.981	60.020
	SXGA@75Hz	1280	1024	79.976	75.025
	Mac13"	640	480	35.000	66.666
	Mac16"	832	624	49.725	74.550
	Mac19"	1024	768	60.241	74.926
	Mac21"	1152	870	68.681	75.061

4. PC format ② ----- Digital signals sent to the DVI input terminal

	Type of signal	H active (pixels)	V active (lines)	f (H) (kHz)	f (V) (Hz)
VESA	VGA@60Hz	640	480	31.469	59.940
	SVGA@60Hz	800	600	37.879	60.316
	XGA@60Hz	1024	768	48.363	60.003
	1280x960@60Hz	1280	960	60.000	60.000
	SXGA@60Hz	1280	1024	63.981	60.019

- VESA is trademark of Video Electronics Standards Association.
- Macintosh is a trademark of Apple Computer, Inc.

■ Menu items and input signals

A menu item can or cannot be adjusted depending on the type of input signal. The following list shows the types of input signals that can be adjusted for each item in the menu groups ① <IMAGE> and ② <SIGNAL>. Most of these items can store their settings in the memory (MEMORY 1—6). Refer to page 25. The items in the menu groups ③ <INITIAL> and ④ <SETUP> store their settings in this unit when adjusted.

<IMAGE>

MENU ITEM	NOTE	Type of input signal			
		Composite/ S video signal	Component signal (480i—1080i)	RGB TV	RGB PC/DVI
BLACK LEVEL	M	✓	✓	✓	✓
CONTRAST	M	✓	✓	✓	✓
BRIGHTNESS	M	✓	✓	✓	✓
GAMMA TRIM	M	✓	✓	✓	✓
SHARPNESS*	M	✓	✓	✓	✓
HUE**	M	✓			
SATURATION**	M	✓			
COLOR BOOST	M		✓		
COLOR TEMP	M	✓	✓	✓	✓
WHITE BALANCE					
CONTRAST (RGB)	M	✓	✓	✓	✓
BRIGHTNESS (RGB)	M	✓	✓	✓	✓
WHITE BOOST	M	✓	✓	✓	✓

* Three kinds of setting can be stored in memory for different types of input signals (ordinary video signal, HDTV, RGB PC/DVI).

** “HUE” and “SATURATION” cannot be adjusted when the input signal is SECAM.

<SIGNAL>

MENU ITEM	NOTE	Type of input signal								
		Composite/ S video signal			Component signal				PC signal	
		NTSC	NTSC-S	Others	480i	480p	576i	720i/1080i	RGB	DVI
ASPECT	A	✓	✓	✓	✓	✓	✓	✓	✓	✓
SUBTITLE MASK		✓	✓	✓	✓	✓	✓			
MASK POSITION		✓	✓	✓	✓	✓	✓			
3D Y/C SEPARATION	M	✓								
NOISE REDUCTION	M	✓	✓	✓	✓		✓			
VIDEO TYPE	M	✓	✓	✓						
SETUP LEVEL	M	✓	✓		✓	✓		✓		
DOT PHASE	S								✓	
SIZE H	S								✓	
SHIFT H	S								✓	
SHIFT V	S								✓	
SIGNAL STATUS									✓	✓

◆ Note ◆

M: Items that can be stored in memory. Six patterns can be stored and recalled by pressing the **MEMORY** button on the remote control.

S: Several patterns of the latest information can be stored in this unit depending on the type of input signals. This is convenient when projecting the RGB signals.

A: Depending on the setting for “SCREEN ASPECT”, one display aspect can be stored for each type of input signal listed below.

SCREEN ASPECT	ASPECT	Type of input signal		
		Ordinary video signal (Composite, S video, 480i/ 480p/576i)	HDTV signal (720p/1080i)	PC signal (RGB/DVI)
4:3	AUTO	✓		✓
	NORMAL	✓	✓	✓
	SQUEEZE	✓	✓	✓
	ZOOM	✓	✓	✓
	THROUGH -SQUEEZE-	✓		✓
16:9	AUTO	✓		✓
	NORMAL	✓	✓	✓
	SQUEEZE	✓	✓	✓
	ZOOM	✓	✓	✓
	ZOOM -SUBTITLE- THROUGH -SQUEEZE-	✓		✓

Additional information

■ Message display

Message	Condition
NO SIGNAL	This unit is not receiving any input signal.
INPUT A <COMPONENT> (Example)	The input name selected by the INPUT button is displayed. It will turn off 1 minute after the signal has been input.
OUT OF RANGE	This unit cannot receive the PC signal that is coming into this unit.
UNKNOWN FORMAT	This unit cannot receive the video signal that is coming into this unit.
AUTO SYNC...	This unit is making the most appropriate setting according to the input RGB signal being received.
STILL	The STILL (freezing the image) function has been activated.
STILL OFF	The STILL (freezing the image) function has been cancelled.
MEMORY 1—6	The memory setting number selected is displayed and turns off after 1 minute.
ESCAPE:EXIT (Example)	Help messages are displayed for easier menu operation.
LAMP REPLACEMENT TIME HAS COME. PLEASE REPLACE WITH A NEW LAMP. PRESS "ESCAPE" TO REMOVE THIS INDICATION.	This message is displayed when the power switch is turned on after the lamp running time has exceeded 1000 hours. Press the ESCAPE button to turn off the message.
PRESS AGAIN FOR STANDBY.	This unit will enter the standby mode and the lamp will turn off if the STANDBY/ON button is pressed again.

Maintenance

■ Regular care

Disconnect the power cable from this unit before starting regular care. Clean the housing of this unit with a soft cloth. If heavily soiled, use a damp cloth with a mild detergent and then wipe with a dry cloth again. Do not use strong detergents or solvents such as alcohol or thinner to prevent from damaging the finish or shape of the unit. When cleaning the housing, do not directly touch or rub the lens.

■ Cleaning the filter

If dust has accumulated on the filter attached in the ventilation slot, the air does not circulate well and the temperature inside this unit will rise. This may cause damage to this unit. Clean the filter every 200 hours. If you find difficulty clearing the dust, replace it with new one.

- 1. Turn off the power and disconnect the power cable from this unit.**
- 2. Pull down the filter holders located on the rear of this unit. Remove the filter frame by pulling it toward you and then downward.**

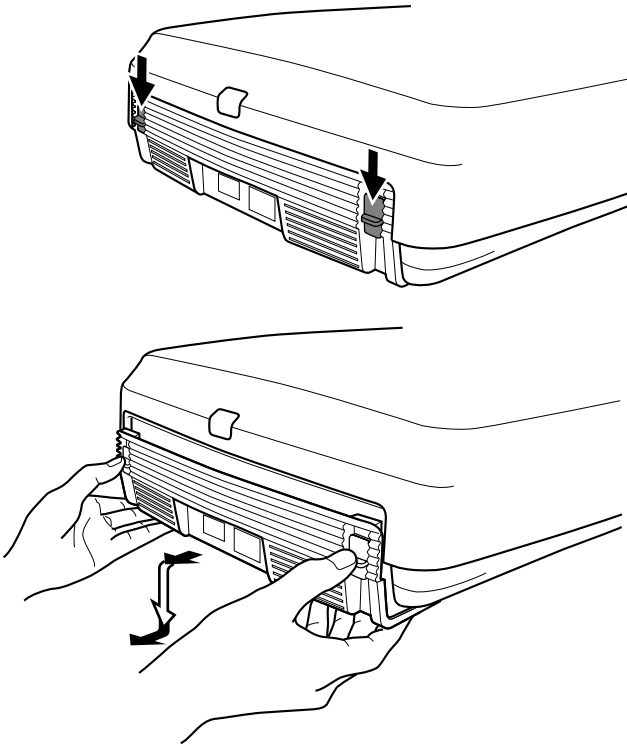

- 3. Remove the wire remains placed inside the filter frame that snaps into place behind four tabs. Then remove the thin sponge filter from both sides.**

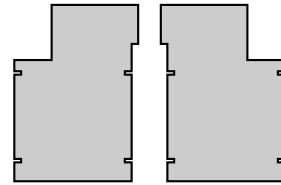
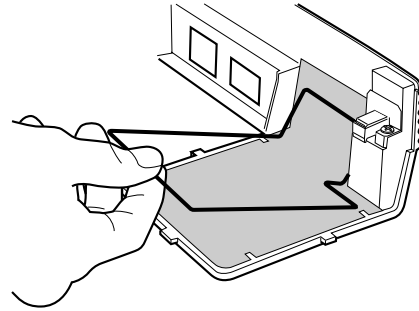

- 4. Carefully clean and wash the removed filters to eliminate accumulated dust.**
- 5. After the cleaned filters are completely dry, put them back on this unit. If they are not refitted correctly, the lamp will not turn on.**

Important

- If the filter is heavily soiled, replace it with the new one supplied.
- When you need more filters for replacement, contact the store where this unit was purchased.

■ Replacing the lamp cartridge

Important

- **Make sure to use the lamp cartridge PJL-112 for replacement. Other cartridge is not applicable to this unit.**

The lamp used as the source of light is a consumable and will gradually lose its brightness over the course of usage. It is recommended that the lamp should be replaced when its usage exceeds 1000 hours in order to enjoy the best image possible.

“LAMP RUNNING TIME” in the menu group ③ <INITIAL> tells you how many hours the lamp has been used so far. The LAMP/COVER indicator also lets you know the lamp replacement timing by flashing in red after the lamp usage has exceeded 1000 hours. (See page 14.) A message to replace the lamp will be displayed on the screen as well. Follow the following steps to replace the lamp with a new one.

For details, consult the store where this unit was purchased.

Important

- **Before starting to replace the lamp cartridge, turn off the power, disconnect the power cable after the fan has completely stopped, and wait at least one hour for the lamp to cool down.**
- **Do not remove any other screws than those specified in the following steps.**

- 1. Carefully place this unit upside down on cloth spread on the floor to prevent from creating any scratches.**

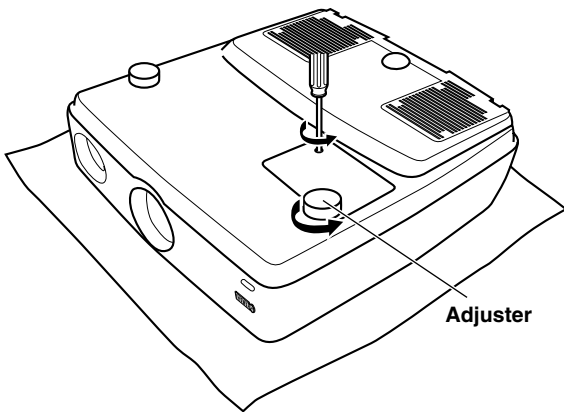

- 2. Loosen the adjuster to remove the lamp cover.**
- 3. Loosen the screws of the lamp cover.**
- 4. Remove the lamp cover.**

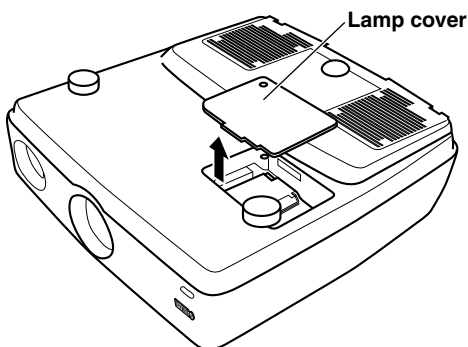

- 5. Completely loosen the three screws securing the lamp cartridge.**

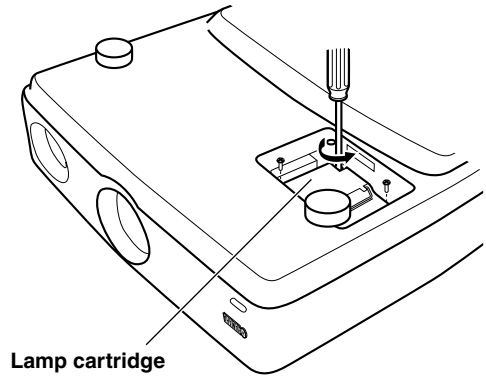

- 6. Hold the handle and pull up the lamp cartridge.**

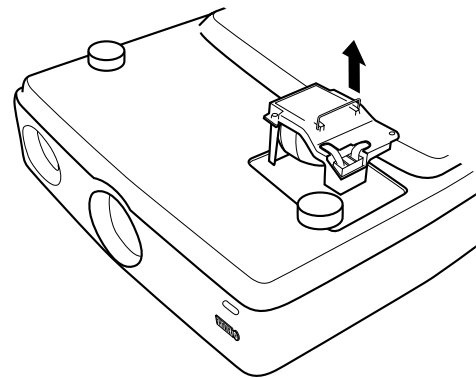

- 7. Secure the new lamp cartridge with the screws by reversing the steps described above.**
- 8. Put the lamp cover back and secure it with the screws.**
If it is not correctly installed, the lamp will not light up.
- 9. Turn on the power switch and reset the “LAMP RUNNING TIME” on the menu when the lamp is turned on. (See page 22.)**

Troubleshooting

Problem	Cause	Remedy
This unit does not turn on.	The power switch is not turned on.	Turn on the power switch.
	You attempted to turn on this unit again just after having turned off the power switch.	Wait a little longer. This unit does not turn on for 2 minutes after the power switch has been turned off to protect the lamp.
	The filter cover is not correctly attached.	Correctly attach the filter cover.
	The lamp cover is not correctly attached.	Correctly attach the lamp cover.
No picture	The lens cap has not been removed.	Remove the lens cap.
	This unit is not correctly connected to the other components.	Check the connection.
	The input signal has not been correctly selected.	Select the correct input signal with the INPUT button.
		Press the AUTO button.
	The input signal has not been correctly selected in "INPUT A SIGNAL" and "INPUT B SIGNAL" on the menu.	Select the correct input signal.
	The picture is turned off temporarily by the HIDE function.	Press the HIDE button again to cancel the HIDE function.
The computer is not set to display on the external monitor.	Make an appropriate setting on the computer to display on the external monitor. (Also refer to the operation instructions of the computer.)	
Image is unstable.	The connection cables are not correctly connected to this unit.	Correctly connect the cables to the appropriate terminals.
Picture is blurred.	The lens is not correctly focused.	Adjust the focus of the lens with the focus ring.
	This unit and the screen are not placed squarely (90 degrees).	Adjust the projection angle and direction, and the height of this unit.
Remote control does not work correctly.	The batteries are exhausted.	Replace both batteries with new ones.
	The remote control sensor is not correctly selected in "R/C SENSOR" on the menu.	Select an appropriate remote control sensor.
	There is a fluorescent lamp near the remote control sensor being used.	Select the other sensor in "R/C SENSOR" on the menu that the fluorescent lamps will not interfere with.
LAMP/COVER indicator lights up.	The filter cover is not correctly attached.	Tightly attach the filter cover.
	The lamp cover is not correctly attached.	Tightly attach the lamp cover.
LAMP/COVER indicator flashes.	The lamp has exceeded its specified usage hours.	Replace the lamp with a new one.
	The lamp has burned out.	Replace the lamp with a new one.
TEMP/FAN indicator lights up.	The temperature inside this unit is extremely high.	Check that the ventilation slots are not covered.
TEMP/FAN indicator flashes.	The fan is broken.	Contact the store where this unit was purchased.

Specifications

■ Specifications

Optical

Projection mode	DLP™ (Digital Light Processing) Images of 1024 x 768 pixels, 0.9 inch
Lens	f=35 to 42 mm F=2.7 to 3.0 Manual zoom (x 1.2) Manual focus
Lamp	120 W VIP lamp
Image size	200 inches at maximum Projection distance 10.6 m (35 ft.) (wide image, 16:9 screen)
Luminosity	800 ANSI lm
Contrast ratio	900:1

Electrical

Color mode	NTSC, PAL, SECAM, NTSC ^{4.43} , PAL-M, PAL-N, PAL60
Scanning frequency	H:15 to 80 kHz;V:50 to 85 Hz

Input

VIDEO	Composite signal 1Vp-p/75Ω, negative sync.
S VIDEO	S video signal Y: 1Vp-p/75Ω, negative sync. C: 0.286 or 0.3Vp-p/75Ω
D4 VIDEO	Component signal Y with sync.: 1Vp-p/75Ω, negative sync. (480i, 576i, 480p) Y with sync.: 1Vp-p/75Ω, 3 values sync. (1035i, 1080i, 720p) P _B , Pr: 0.7Vp-p/75Ω
INPUT A/INPUT B	Component signal Y with sync.: 1Vp-p/75Ω, negative sync. (480i, 576i, 480p) Y with sync.: 1Vp-p/75Ω, 3 values sync. (1035i, 1080i, 720p) P _B , Pr: 0.7Vp-p/75Ω
	RGB signal G with sync.: 1Vp-p/75Ω, negative sync. (480i, 576i, 480p) G with sync.: 1Vp-p/75Ω, 3 values sync. (1035i, 1080i, 720p) G: 0.7Vp-p/75Ω (when using HD/VD or SYNC) B, R: 0.7Vp-p/75Ω HD, VD: TTL level (positive and negative)/2.2 kΩ SYNC: 2Vp-p/2.2kΩ, negative sync. (480i, 576i)
DVI	Digital RGB signal

Controls

Remote	RS-232C (D-Sub 9 pin)
Trigger	+12 V when the power is on; 0 V when the power is off (mini jack)

Remote control sensor

..... 1 in front and 1 at rear

General

Usable temperature range	5°C to 35°C
Usable humidity range	30% to 85% (There should be no condensation.)
Power supply	AC 100 to 120 V/220 to 240 V, 50/60 Hz
Power consumption	185 W Standby mode 10 W
Dimension	415 (W) x 129 (H) x 422 (D) mm 16-3/8 (W) x 5-1/16 (H) x 16-5/8 (D) inch
Weight	7.8 kg (17 lbs 3 oz)

■ Accessories

• Power cord	1
• Plug adapter	1
• Wireless remote control	1
• Batteries (AA, UM-3 or R6)	2
• Pin/BNC adapter	3
• Lens cap	1
• Filter for replacement	2
• Owner's Manual	1

* Specifications are subject to change without notice.

■ Dimensional drawing

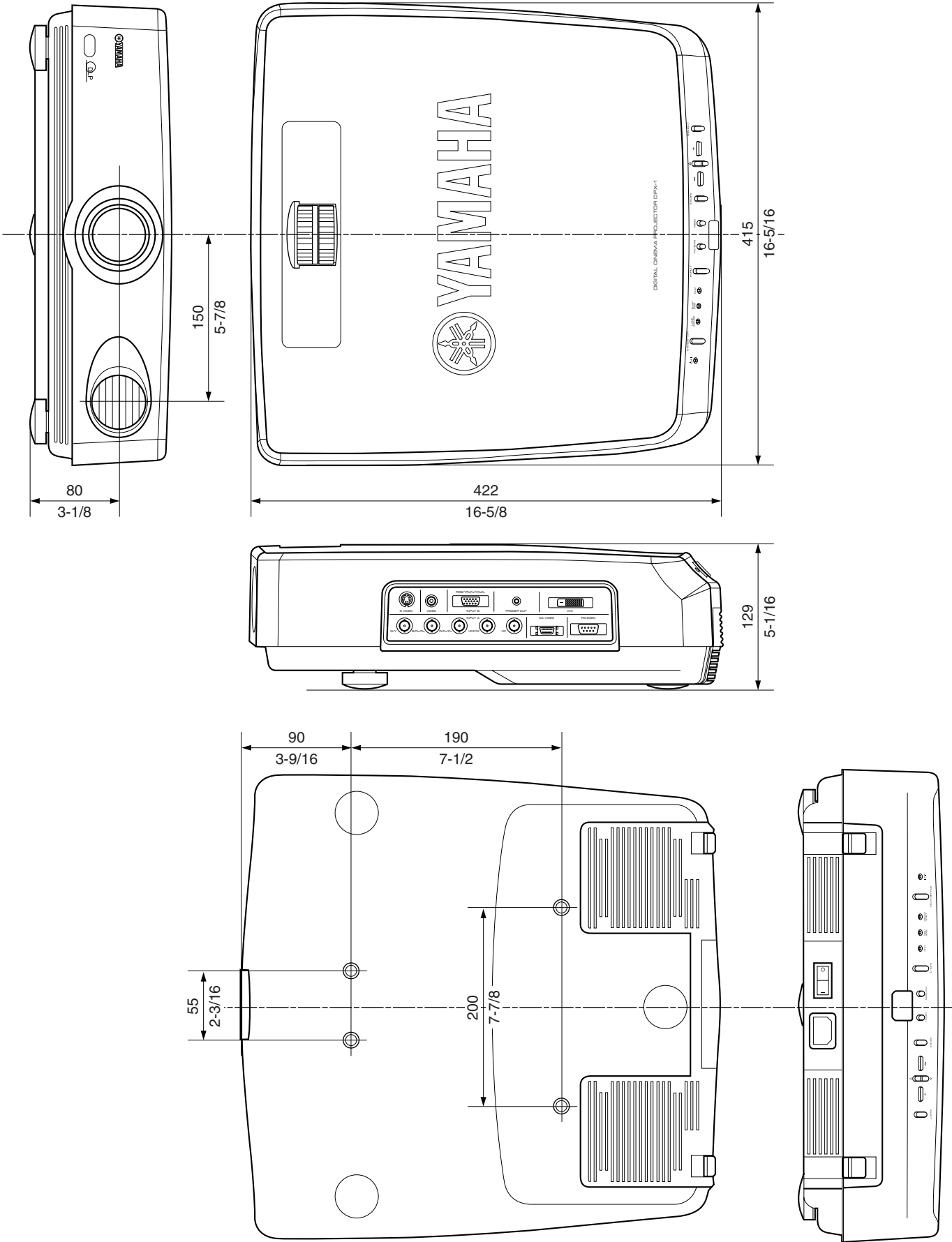

ADDITIONAL
INFORMATION

English

